

CHAINTECH

7NJL1

AMD Socket A

NVIDIA nForce 2 SPP + MCP

ATX Motherboard

User's Guide

Version 2.0



Declaration of Conformity

According to 47 CFR, Parts 2 and 15 of the FCC Rules

The following designated product:

EQUIPMENT: MAINBOARD

MODEL NO.: 7NJL1

is a Class B digital device that complies with 47 CFR Parts 2 and 15 of the FCC Rules. Operation is subject to the following two conditions:

1. This device may not cause harmful interference.
2. This device must accept any interference received, including interference that may cause undesired operation.

This declaration is given to the manufacturer:

CHAINTECH-EXCEL COMPUTER INC.

4427 Enterprise St. Fremont, CA 94538, U.S.A.

<http://www.chaintech-excel.com>

Chaintech President: Simon Ho

Signature: 

Contents

Federal Communications Commission Statement

This device complies with FCC Rules Part 15. Operation is subject to the following two conditions:

- * This device may not cause harmful interference.
- * This device must accept any interference received, including interference that may cause undesired operation.

This equipment has been tested and found to comply with the limits for a Class B digital device, pursuant to Part 15 of the FCC Rules. These limits are designed to provide reasonable protection against harmful interference in a residential installation. This equipment generates, uses, and can radiate radio frequency energy. If this equipment is not installed and used in accordance with the manufacturer's instructions, it may cause harmful interference to radio communications. However, there is no guarantee that interference will not occur in a particular installation. If this equipment does cause harmful interference to radio or television reception, which can be determined by turning the equipment off and on, the user is encouraged to try to correct the interference by one or more of the following measures:

- * Reorient or relocate the receiving antenna.
- * Increase the separation between the equipment and receiver.
- * Connect the equipment to an outlet on a circuit different from that to which the receiver is connected.
- * Consult the dealer or an experienced radio/TV technician for help.

The use of shielded cables for connection of the monitor to the graphics card is required to assure compliance with FCC regulations. Changes or modifications to this unit not expressly approved by the party responsible for compliance could void the user's authority to operate this equipment.

Canadian Department of Communications Statement

This digital apparatus does not exceed the Class B limits for audio noise emissions from digital apparatuses set out in the Radio Interference Regulations of the Canadian Department of Communications.

Manufacturer's Disclaimer Statement

The information in this document is subject to change without notice and does not represent a commitment on the part of the vendor. No warranty or representation, either expressed or implied, is made with respect to the quality, accuracy or fitness for any particular purpose of this document. The manufacturer reserves the right to make changes to the content of this document and/or the products associated with it at any time without obligation to notify any person or organization of such changes. In no event will the manufacturer be liable for direct, indirect, special, incidental or consequential damages arising out of the use or inability to use this product or documentation, even if advised of the possibility of such damages. This document contains materials protected by copyright. All rights are reserved. No part of this manual may be reproduced or transmitted in any form, by any means or for any purpose without expressed written consent of its authors. Product names appearing in this document are mentioned for identification purposes only. All trademarks, product names or brand names appearing in this document are registered property of their respective owners.
Printed in Taiwan.



CHAPTER 1 INTRODUCTION	1
1.1 PRODUCT SPECIFICATIONS	1
1.2 PACKAGE CONTENTS	2
1.3 7NJL1 MOTHERBOARD DIAGRAM	4
1.4 7NJL1 MOTHERBOARD LAYOUT	5
CHAPTER 2 HARDWARE SETUP	6
2.1 INSTALLING A CPU PROCESSOR IN SOCKET A	6
2.2 CPU JUMPER CONFIGURATION	8
2.3 MAIN MEMORY CONFIGURATION	11
2.4 CONNECTOR AND JUMPER REFERENCE CHART	12
2.5 CONNECTOR AND JUMPER SETTINGS	13
2.6 CBOX™ 2 SETUP	27
CHAPTER 3 BIOS SETUP PROGRAM	28
3.1 STANDARD CMOS SETUP	29
3.2 ADVANCED BIOS FEATURES	30
3.3 ADVANCED CHIPSET FEATURES	33
3.4 INTEGRATED PERIPHERALS	35
3.5 POWER MANAGEMENT SETUP	38
3.6 PNP/PCI CONFIGURATIONS	41
3.7 PC HEALTH STATUS	42
3.8 FREQUENCY/VOLTAGE CONTROL	43
3.9 LOAD FAIL-SAFE DEFAULTS	44
3.10 LOAD OPTIMIZED DEFAULTS	44
3.11 SUPERVISOR PASSWORD & USER PASSWORD SETTING	44
3.12 SAVE AND EXIT SETUP	45
3.13 EXIT WITHOUT SAVING	45
CHAPTER 4 DRIVER SETUP	46
4.1 NVIDIA DRIVER PACKAGE SETUP	46
4.2 USB 2.0 DRIVER SETUP	49
4.3 C-MEDIA SOUND DRIVER SETUP	50
CHAPTER 5 AUDIO DEVICE APPLICATION ...	53
5.1 AUDIO RACK	53
5.2 MULTI- CHANNEL DEMO	61
CHAPTER 6 DIGIDOC	62

Contents

DDR MEMORY TEST TABLE	63
CPU FSB=266MHz DDR	63
CPU FSB=333MHz DDR	65
<i>NOTES</i>	67
HOW TO CONTACT CHAINTECH.....	68

Chapter 1 Introduction

1.1 Product Specifications

Processor

- Supports AMD Socket A Duron/Athlon/Athlon XP CPU
- System clock supports 200/266/333MHz

Chipset

- NVIDIA nForce2 SPP + MCP

Main Memory

- Three 184 pin DDR DIMMs up to 3GB
- Supports PC1600/2100/2700/3200 Dual-Channel DDR modules

Expansion Slots

- One universal-AGP slot for both 4X/8X AGP
- Five 32-Bit PCI slots (v2.2 compatible)
- One ACR slot supports modem, or audio

On-board audio CMedia 8738

- Full-duplex operation for simultaneous recording and playback.
- 6 Channel speaker audio supports.
- Embedded 32ohm 5w earphone amplifier.
- Supports MIDI and dual game ports.
- 32 Voice HRTF-3D positional audio, CRL-3D supports MS Direct.
- Sound3D, Aureal A3D and Creative EAX APIs.

Ultra DMA-66/100/133 PCI IDE Controller

- Supports two IDE ports up to 4 ATAPI devices
- Supports PIO Mode 4 up to 16.6MBps, Multi Mode 4 up to 66MBps, Multi Word Mode 5 up to 100MBps and Multi Word Mode 6 up to 133MBps with Bus Mastering.
- Bus-Mastering software drivers for all common multi-tasking operating systems

USB 2.0/1.1 Host Controller

- One EHCI USB 2.0 Controller and 2 UHCI USB 1.1 Controllers
- Support total 6 USB 2.0 Ports (USB1.1 compatible).
- Support USB 2.0 High-Speed Device @480 Mb/s Transfer Rates.

On board Super I/O Controller

- ITE 8712 LPC I/O with system monitors hardware.
- Two UARTs support serial ports and IR function (up to 115.2Kbps) for HPSIR and ASKIR.
- One SPP/ECP/EPP parallel port.
- One floppy disk drive connector supports up to 2.88MB.

Integrates smart card reader function and interface, to be qualified for meeting PC/SC standard.

Fast Ethernet/Home Networking Controller with MII Interface

- Support 10/100Mb Fast Ethernet.

Embedded system monitoring

- 8 external voltage inputs
- 2 temperatures sensing for CPU and system.
- 2 Fan speed (CPU and system) monitoring.

Boot-Block Flash ROM

- Award system BIOS support PnP, APM, DMI, ACPI, & Multi-device.

1.2 Package Contents

This product comes with the following components:

- | | |
|----------------------------|-----|
| 1. Motherboard. | x 1 |
| 2. I / O Panel | x 1 |
| 3. Round Cable: | |
| Include: | |
| - IDE Cable | x 2 |
| - Floppy Cable | x 1 |
| 4. Audio KIT: | |
| Include: | |
| - 6channel kit | x 1 |
| 5. CBOX™2 Package | |
| Include: | |
| - 5-1/4" CBOX™2 | x 1 |
| - USB 10-pin Cable | x 2 |
| - Front Audio 10-pin Cable | x 1 |
| - 80-Port 10-pin Cable | x 1 |
| - IEEE-1394 Cable | x 1 |
| 6. Include: | |
| - User's Guide | x 1 |
| - EZ Manual | x 1 |
| - Driver CD | x 1 |
| - Value-pack 2003 | x 1 |
| 7. Thermal grease pack | x 1 |

Special Features:

1. CBOX™2, Chaintech's exclusive front panel.

Include:

USB (1.1 / 2.0 compliant) Ext. ports	x 4
Earphone (Ø3.5mm) phone jack	x 1
MIC – in (Ø3.5mm) phone jack	x 1
IEEE-1394 Ext. port	x 1

Note: The 7NJL1 excludes the IEEE-1394 function.

If customers require the IEEE-1394 function, please purchase one IEEE-1394 card to expand the function.

DigiDoc System Monitoring Display	x 1
Green LED Display	x 1

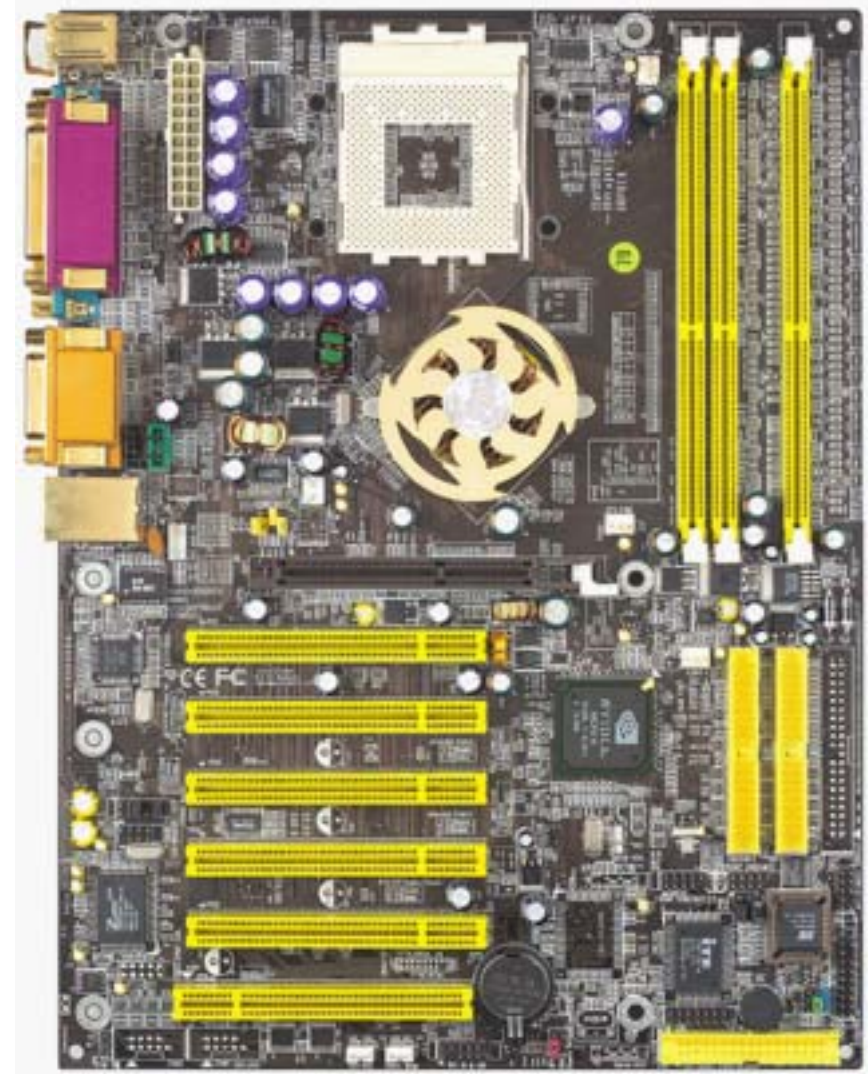

2. One driver CD that includes.
 - Audio drivers and utilities for DOS/Win9x/NT/XP
 - nForce Service Pack for Windows OS including Bus Master IDE drivers, AGP VxD, LAN and etc.
3. Value Pack 2003 software pack including Norton AntiVirus, Adobe ActiveShare, Acrobat Reader, Acrobat eBook Reader, Imagemore and AutoSave.

1.3 7NJL1 Motherboard Diagram

1.4 7NJL1 Motherboard Layout

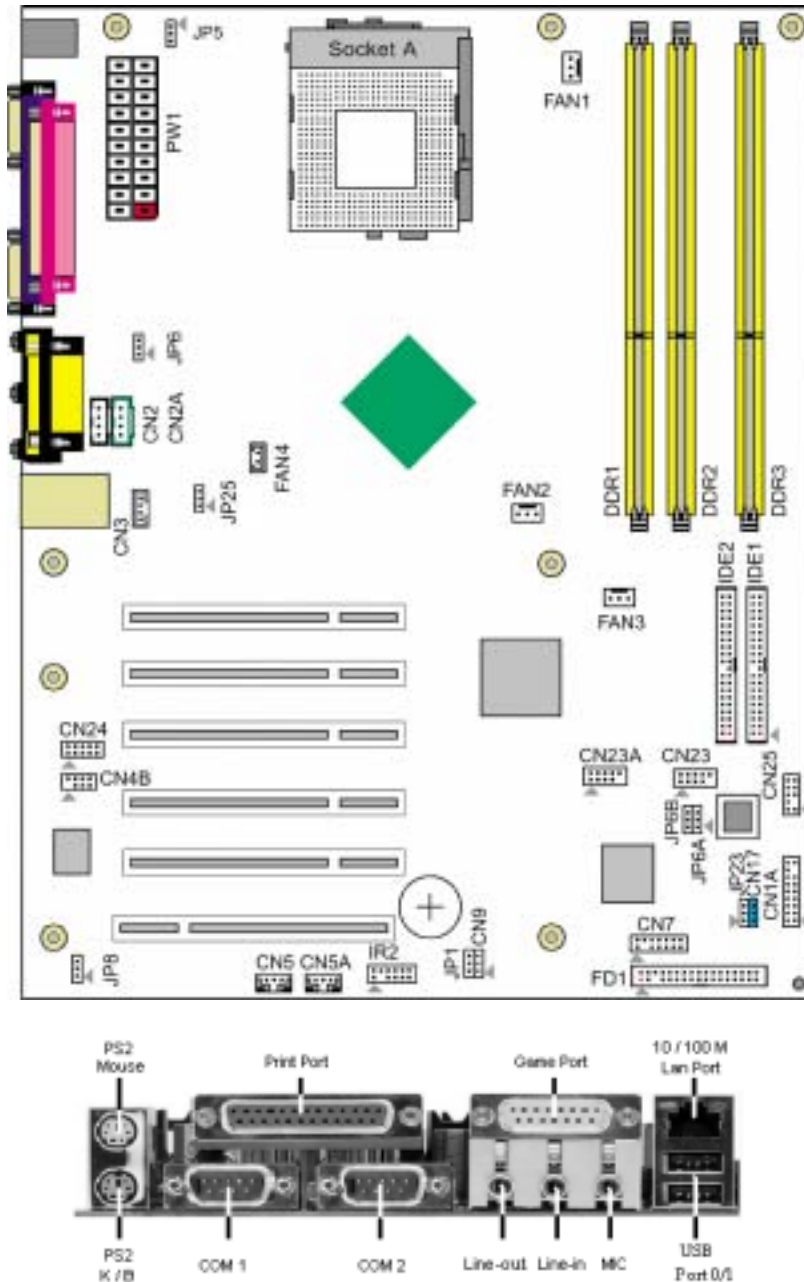

Chapter 2 Hardware Setup

If your motherboard has already been installed in your computer you may still need to refer to this chapter if you plan to upgrade your system's hardware.

This motherboard is electrostatic sensitive. Do not touch without wearing proper safety gadget and make sure to disconnect the power cable from the power source before performing any work on your motherboard. Not doing so may result in electrical shock!

2.1 Installing a CPU Processor in Socket A

The Socket A, designed for AMD Duron/Athlon/Athlon XP processors, has been incorporated as a standard motherboard specification. To insert your CPU into Socket A please do the following:

1. Locate a cut edge on the top surface of the CPU, which is close to one of the CPU corners. The same corner will also be cut off, leaving a noticeable notch in the CPU's corner. These markings indicate Pin 1 on the CPU.

2. Pull up the lever of Socket A so that it is perpendicular with the surface of the motherboard. Gently insert the CPU with Pin 1 at the same corner of Socket A, which is located close to the end of the lever. Allow the weight of the CPU to push itself into place. Do not apply extra pressure as doing so may result in damaging your CPU. Snap the lever back into place.

Installing an AMD approved heat sink with cooling fan is necessary for proper heat dissipation from your CPU. Failing to install these items may result in overheating and possible burnout of your CPU.

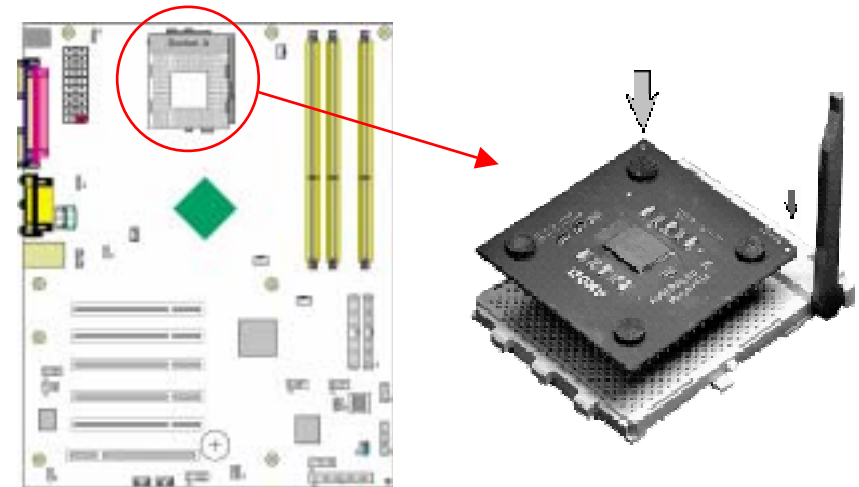

Notes: In order to boot up with a newly installed CPU, AC Power must be switched off before installation.

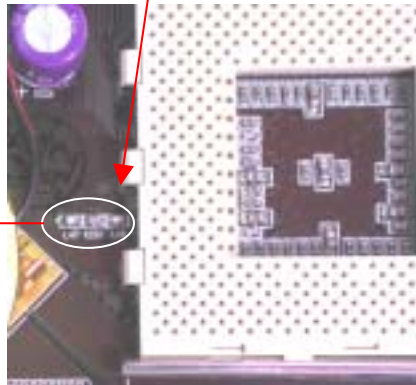
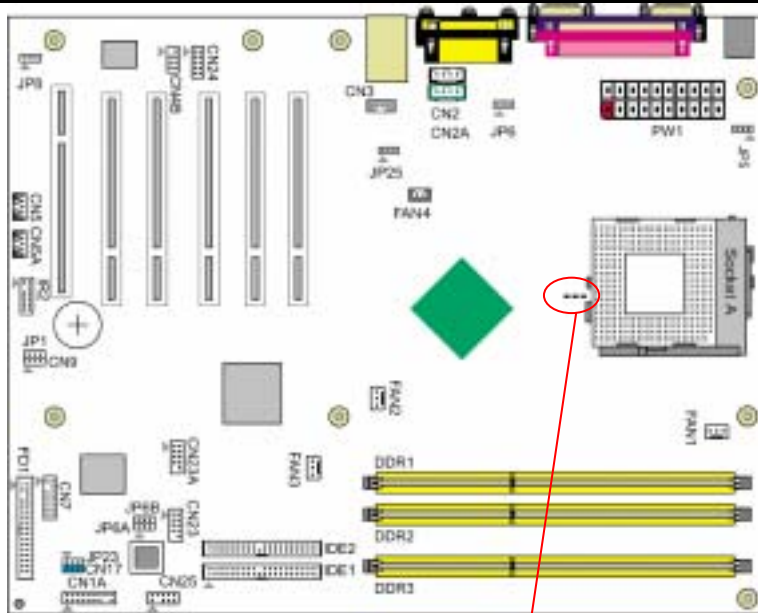

L47 C231 L48

Caution:

Do not hit the components L47, L48 and C231 while installing your heat sink. Inappropriate installation might damage the inductances and capacitance.

2.2 CPU Jumper Configuration

Frequency Configuration:

If you install a CPU on this motherboard, you must set the [External Clock Frequency] JP25 according to your processor (See Section 2.4).

*** CPU Speed = Multiplier x FSB Frequency**

You do not need to make voltage settings because this board will automatically set your CPU voltage.

AMD (K7) Duron CPU

Model	CPU Speed	FSB Frequency	Multiplier	Vcore	L2 Cache	Micron process
600	600 MHz	100	6.0	1.6V	64KB	0.18
650	650 MHz	100	6.5	1.6V	64KB	0.18
700	700 MHz	100	7.0	1.6V	64KB	0.18
750	750 MHz	100	7.5	1.6V	64KB	0.18
800	800 MHz	100	8.0	1.6V	64KB	0.18
850	850 MHz	100	8.5	1.6V	64KB	0.18
900	900 MHz	100	9.0	1.6V	64KB	0.18
950	950 MHz	100	9.5	1.6V	64KB	0.18
1.0G	1.0 GHz	100	10.0	1.6V	64KB	0.18
1.1G	1.1 GHz	100	11.0	1.6V	64KB	0.18
1.2G	1.2 GHz	100	12.0	1.6V	64KB	0.18
1.3G	1.3 GHz	100	13.0	1.6V	64KB	0.18

AMD Athlon CPU (K7/Thunderbird)

Model	CPU Speed	FSB Frequency	Multiplier	Vcore	L2 Cache	Micron process
700	700MHz	100	7.0	1.70V	256KB	0.18
750	750MHz	100	7.5	1.70V	256KB	0.18
800	800MHz	100	8.0	1.70V	256KB	0.18
850	850MHz	100	8.5	1.70V	256KB	0.18
900	900MHz	100	9.0	1.75V	256KB	0.18
950	950MHz	100	9.5	1.75V	256KB	0.18
1000	1000MHz	100	10.0	1.75V	256KB	0.18
1100	1100MHz	100	11.0	1.75V	256KB	0.18
1200	1200MHz	100	12.0	1.75V	256KB	0.18
1300	1300MHz	100	13.0	1.75V	256KB	0.18
1400	1400MHz	100	14.0	1.75V	256KB	0.18
1000	1000MHz	133	7.5	1.75V	256KB	0.18
1113	1113MHz	133	8.5	1.75V	256KB	0.18
1200	1200MHz	133	9.0	1.75V	256KB	0.18
1333	1333MHz	133	10.0	1.75V	256KB	0.18
1400	1400MHz	133	10.5	1.75V	256KB	0.18

AMD Athlon XP CPU (Palomino/Thoroughbred)

Model	CPU Speed	FSB Frequency	Multiplier	Vcore	L2 Cache	Micron process
1500+	1333MHz	133	10.0	1.7V	256KB	0.18
1600+	1400MHz	133	10.5	1.7V	256KB	0.18
1700+	1467MHz	133	11.0	1.7/1.6V	256KB	0.18/0.13
1800+	1500MHz	133	11.5	1.7/1.6V	256KB	0.18/0.13
1900+	1600MHz	133	12.0	1.7/1.6V	256KB	0.18/0.13
2000+	1666MHz	133	12.5	1.7/1.6V	256KB	0.18/0.13
2100+	1733MHz	133	13.0	1.7/1.6V	256KB	0.18/0.13
2200+	1800MHz	133	13.5	1.65V	256KB	0.13
2400+	1995MHz	133	15.0	1.65V	256KB	0.13
2600+	2128MHz	133	16.0	1.65V	256KB	0.13
2700+	2158MHz	166	13.0	1.65V	256KB	0.13

2.3 Main Memory Configuration

The DDR SDRAM memory system consists three banks, each bank supports up to 1GB of memory.

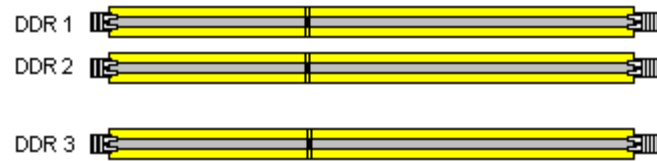

DDR SDRAM Specifications

Memory Frequency	Internal System BUS Frequency
100 MHz	200 MHz
133 MHz	266 MHz
166 MHz	333 MHz
200 MHz	400 MHz

DIMM type: 2.5V, unbuffered 184 pin 64/128/256/512-bit DDR SDRAM

Module size: Single/double-sided 64/128/256/512MB/1GB

Parity: Either parity or non-parity

Location	64 MB	128 MB	256 MB	512 MB	1.0 GB
DDR 1	X	X	X	X	X
DDR 2	X	X	X	X	X
DDR 3	X	X	X	X	X

Note:

For maximized **Dual-channel (128-bit)** result, you must install one of your **two memory modules on DDR3**.

Memory compatibility test please refer to **Appendix DDR Memory Test**.

2.4 Connector and Jumper Reference Chart

Jump Connector	Function	Page
PW1	ATX Power Supply Connector	13
CN1A	Front Panel (Power / Rest / SPK...etc.) Connector	14
FD1	Floppy Connector	15
IDE1 / 2	IDE Hard-Disk Connector	16
JP1	CMOS Clear Jumper	16
JP25	Setup CPU FSB. Freq. Jumper	17
JP8	Onboard Audio Enable Function Jumper	17
CN2 / 2A	CD Audio-in Connector	18
CN3	Aux-in Connector	18
CN4B	6 Channel KIT Connector	19
JP6	Disable/Enable USB 0/1 Device Power ON Jumper	19
JP6A / B	Disable/Enable USB 2/3,4/5 Device Power ON Jumper	20
CN23 / 23A	CBOX™2 Front USB Connector	20
CN24	CBOX™2 Front Audio Connector	21
CN25	CBOX™2 DigiDoc System Display Connector	21
FAN1 / 2 / 3	CPU/ System / Case FAN Connector (12V)	22
FAN4	North Bridge Cooling Fan Power Connector (12V)	22
JP5	Keyboard Power on Function Jumper	23
CN5 / 5A	Wake on LAN / Modem Connector	23, 24
IR2	IR / CIR Connector	24
JP23	Green LED Mode Jumper	25
CN17	Blue LED Connector (5V)	25
CN9	Chassis Open Alarm Connector	26
CN7	Smart Card Reader Connector	26

2.5 Connector and Jumper Settings

Connectors are used to link the system board with other parts of the system, including the power supply, the keyboard, and the various controllers on the front panel of the system case.

The power supply connector is the last connection to be made while installing a motherboard. Before connecting the power supply, please make sure it is not connected to the power source.

Note: All cables are security-proof.

PW1 (ATX Power Supply Connector):

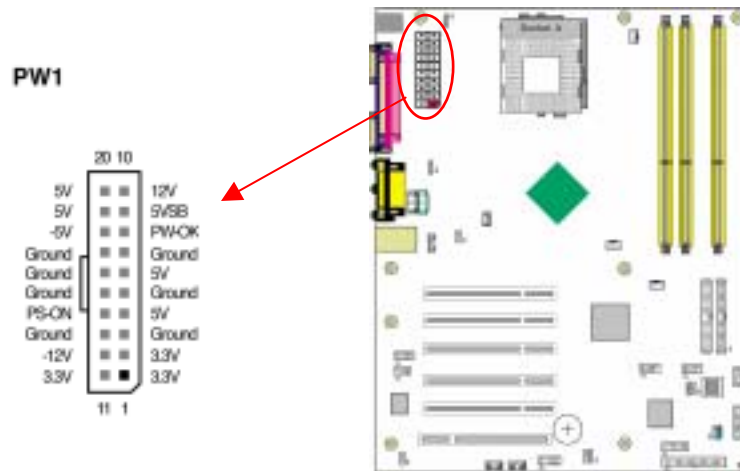

The power cord leading from the system's power supply to the external power source must be the very last part connected when assembling a system. The ATX power supply provides a single 20-pin connector interface, which incorporates standard +/-5V, +/-12V, optional 3.3V and soft-power signals. The soft-power signal, a 5V trickle supply is continuously supplied when AC power is available. When the system is in the Soft-Off mode, this trickle supply maintains the system in its minimum power state.

Power-On By Modem:

While in Soft-Off state, if an external modem ring-up signal occurs, the system wakes up and can be remotely accessed. You may enable this function in BIOS's Power Management Setup menu. (See section 3.5)

Blinking LED in Suspend Mode:

While in Suspend mode, the LED light on the front panel of your computer will flash. Suspend mode is entered by pressing the Override Power Button, pushing the Green button on your ATX case, or enabling the Power Management and Suspend Mode options in BIOS's Power Management menu. (See section 3.5)

Poly-fuse Over Current Protection:

The poly-fuse protects the system from dangerous voltages that the system might be exposed to via the keyboard or USB connector. In case of such exposure, the poly-fuse will immediately be disconnected from the circuit, just like a normal fuse. After being disconnected for a certain period of time, the poly-fuse will return to its normal state. Then the keyboard or USB connector can function properly again. Unlike conventional fuses, the poly-fuse does not have to be replaced, relieving the user wasted time and inconvenience.

CN1A (Front Panel Connector) A through F:

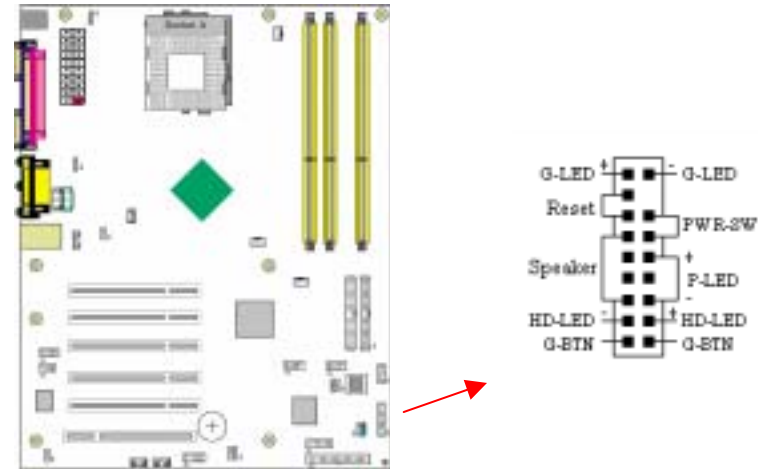

A. PWR-SW (Over-ride Power Button Connector):

The power button on the ATX chassis can be used as a normal power switch as well as a device to activate Advanced Power Management Suspend mode. This mode is used for saving electricity when the computer is not in use for long periods of time. The Soft-OFF by PWR-BTN function in BIOS's Power Management Setup menu must be set to **[Delay 4 Sec.]** to activate this function.

When the Soft-OFF by PWR-BTN function is enabled, pushing the power button rapidly will switch the system to Suspend mode. Any occurrence of external activities such as pressing a key on the keyboard or moving the mouse will bring the system back to Full-On. Pushing the button while in Full-On mode for more than **[4 seconds]** will switch the system completely off. See Over-ride Power Button Operation diagram.

B. P-LED (Power LED Connector):

The power indicator LED shows the system's power status. It is important to pay attention to the correct cables and pin orientation (i.e., not to reverse the order of these two connectors.)

C. G-BTN/G-LED (Green Button Switch/LED Connector):

Some ATX cases provide a Green button switch, which is used to put the system in Suspend mode. In Suspend mode, the power supply to the system is reduced to a trickle, the CPU clock is stopped, and the CPU core is in its minimum power state. The system is woken up whenever the keyboard or mouse is touched. The system resumes in different ways as defined by Power Management Setup screen in BIOS.

D. RESET (System Reset Switch Connector):

This connector should be connected to the reset switch on the front panel of the system case. The reset switch allows you to restart the system without turning the power off.

E. SPEAKER (Speaker Connector):

This 4-pin connector connects to the case-mounted speaker

F. HD-LED (IDE Activity LED Connector):

The IDE activity LED lights up whenever the system reads/writes to the IDE devices.

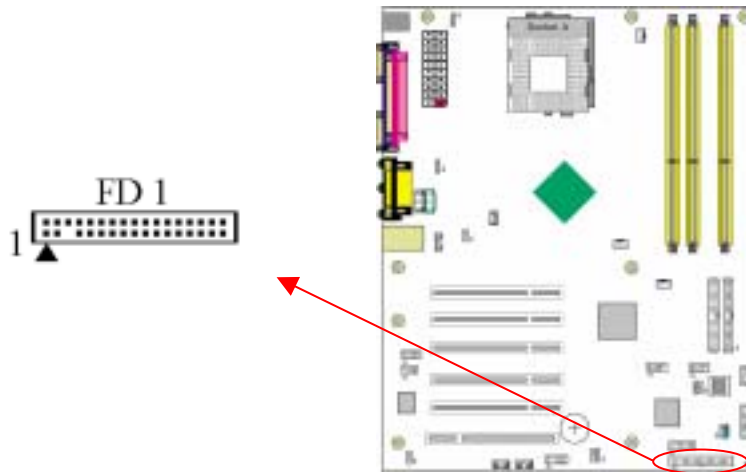
FD1 (Floppy Disk Connector)

This connector is used to connect 34 pins of Floppy.

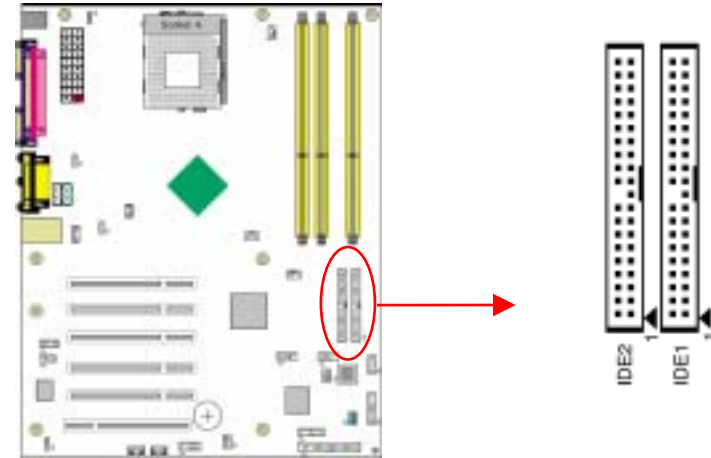
IDE 1/2 (IDE Hard-Disk Connector)

This connector is used for connecting 40 pins of ATAPI devices.
IDE 1 only connects two IDE devices. (**Primary** Master/Slave)
IDE 2 only connects two IDE devices. (**Secondary** Master/Slave)

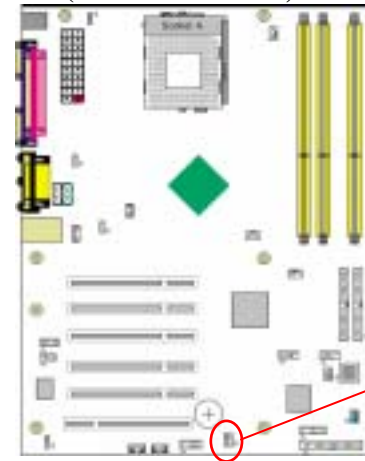
JP1 (Clear CMOS Data):

Pin	Definition
1-2	Normal (default)
2-3	Clear CMOS Data

To clear the contents of the CMOS, please follow the steps below.

1. Disconnect the system power supply from the power source.
2. Set the jumper cap at location [2-3] for <5 seconds>, and then set it back to the default position.
3. Connect the system's power and then start the system.
4. Enter BIOS's CMOS Setup Utility and choose Load Setup Defaults. Type [Y] and press [enter].
5. Set the system configuration in the Standard CMOS Setup menu.

JP25 (Setup CPU FSB Freq.):

Pin	Definition
1-2	133/166 MHz (default)
2-3	100 MHz

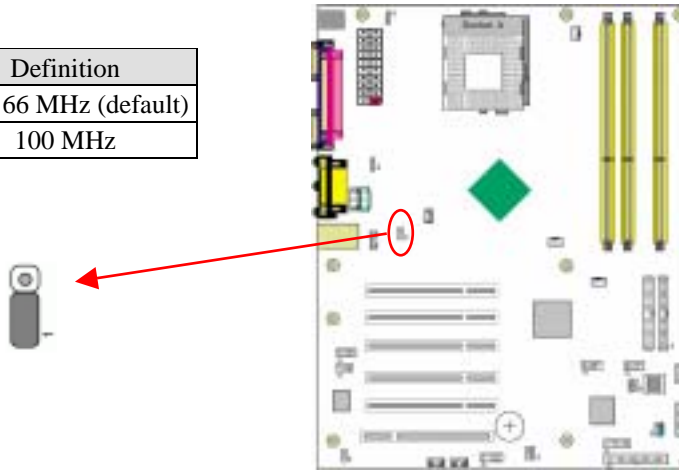

This cap setups up the CPU Ext. Clock Frequency.

1-2: The default value is **133/166 MHz** (The will allow the CPU's Ext. Frequency and memory frequency to be adjusted through the BIOS.).

2-3: Set 100 MHz at CPU Ext. frequency. (The will allow the Memory frequency to be adjusted through the BIOS.)

JP8 (On board Audio Enable/Disable):

Pin	Definition
1-2	Enable (default)
2-3	Disable

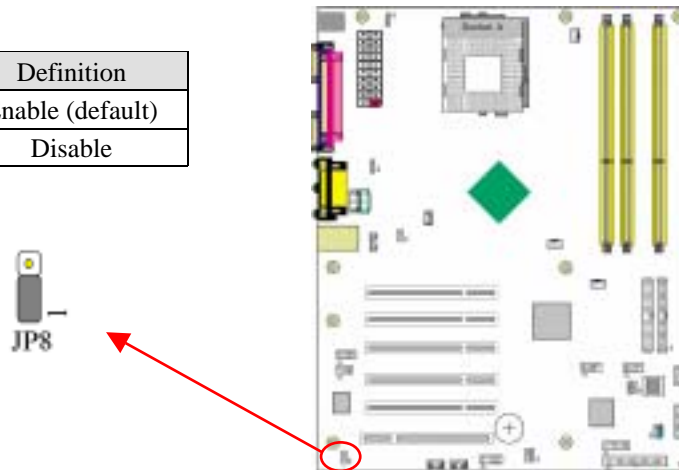

This function allows you to enable or disable the on board audio. You must set the jumper cap to pins **1-2** to **enable** or set pins **2-3** to **disable** this function.

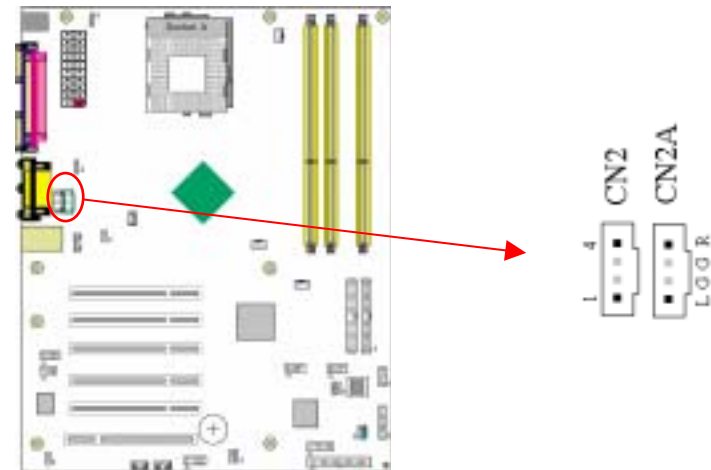
CN2/CN2A (CD-ROM Audio-in Connector):

Use the audio cable enclosed with your CD-ROM disk drive to connect the CD-ROM to your motherboard. This will enable your CD-ROM's audio function.

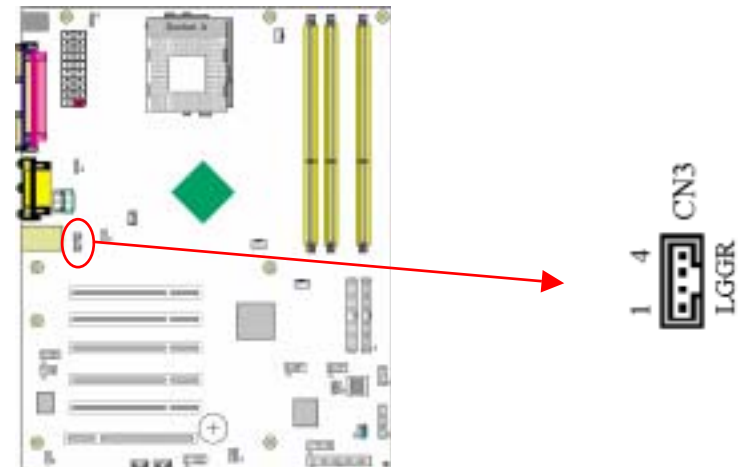
CN3 (Auxiliary Audio-in Connector):

This connector is for AUX Audio Device.

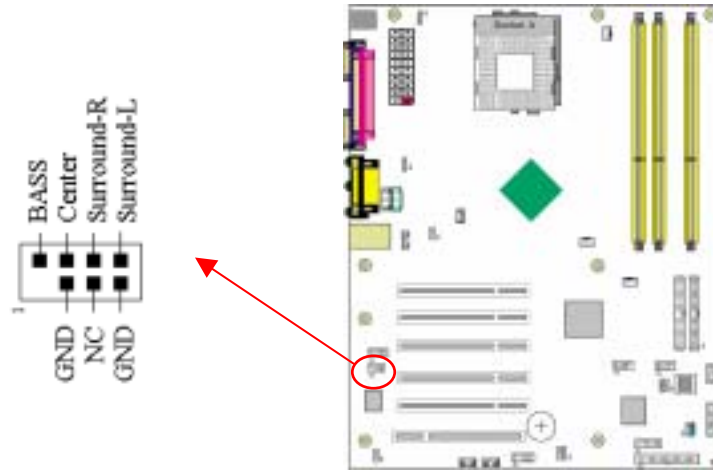
CN4B (AC3 Center / Surround + Bass Connector):

This connector must be connected to a **6-channel bracket**.

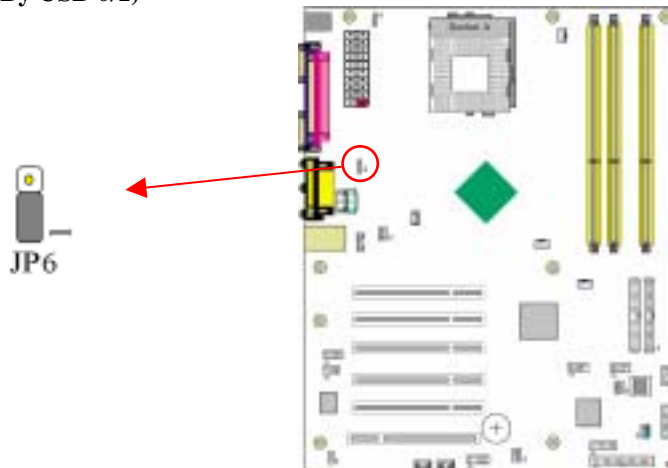
JP6 (Power On By USB 0/1)

A USB keyboard hot key or a USB mouse click can turn on this board. You must also set this jumper's cap to pins 2-3 to use this function.

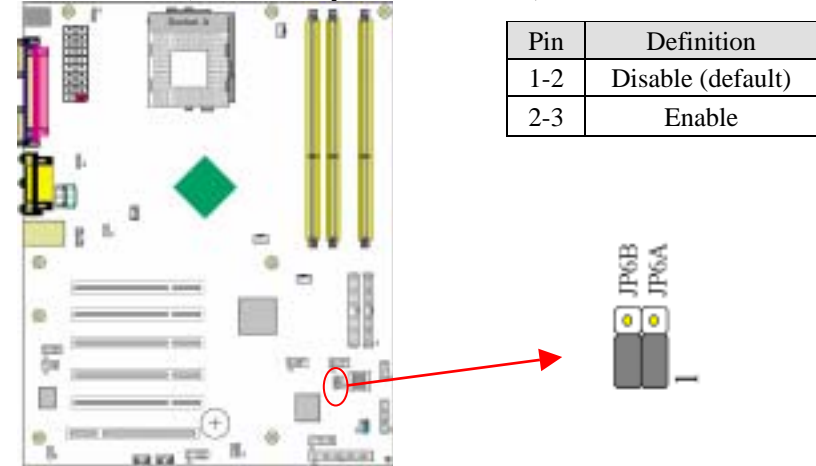
JP6A & JP6B (Power On By USB 2/3 and 4/5):

JP6A → USB 2/3, JP6B → USB 4/5

A USB keyboard hot key or a USB mouse click can turn on this board. You must also set this jumper's cap to pins 2-3 to use this function.

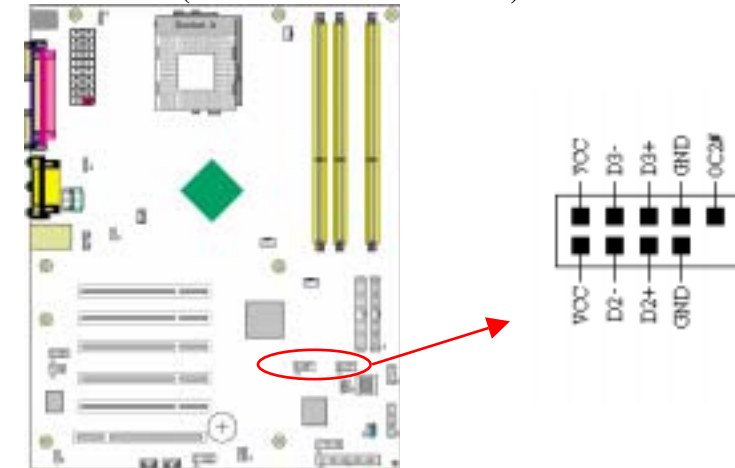
CN23/CN23A (USB 2/3 and 4/5 Connectors):

USB Port 2/3 → CN23, USB Port 4/5 → CN23A

If you want to use a USB Keyboard, you must enable the USB keyboard support function in BIOS's Integrated Peripherals menu (See Section 3.4). This board contains a USB Host controller and includes a root hub with two connector for optional USB Adaptor (USB 2/3 and 4/5).

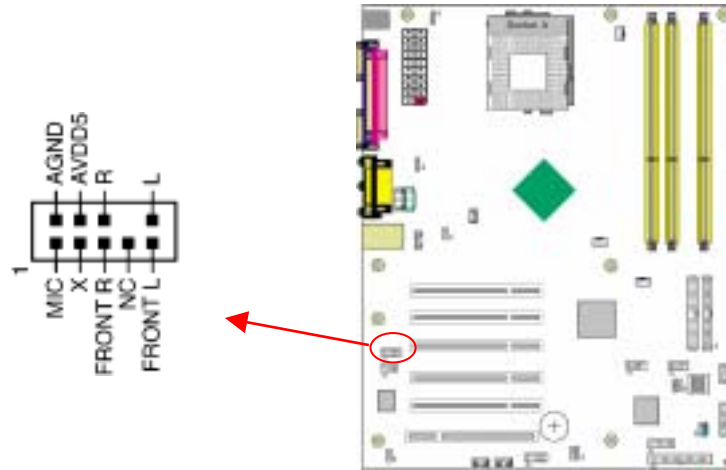
CN24 (CBOX2 Front Panel Audio Connector):

This connector give you the option of a front panel audio jack cable ext. to be plug into a special custom designed system case. Simply remove the two jumper caps at pin [5-6] and [9-10] then plug it into the (optional) cable ext. connector. Pin [5-6] and [9-10] are shorted (default) to enable the back panel audio function.

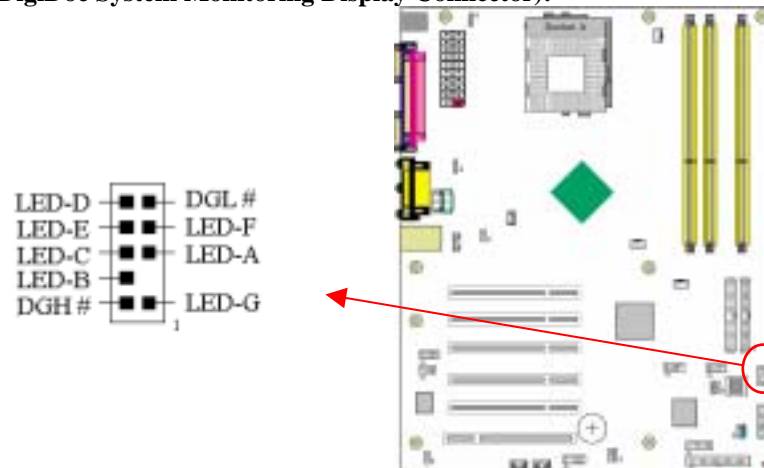
CN25 (DigiDoc System Monitoring Display Connector):

This connector must be connected to an optional DigiDoc System Monitoring Display

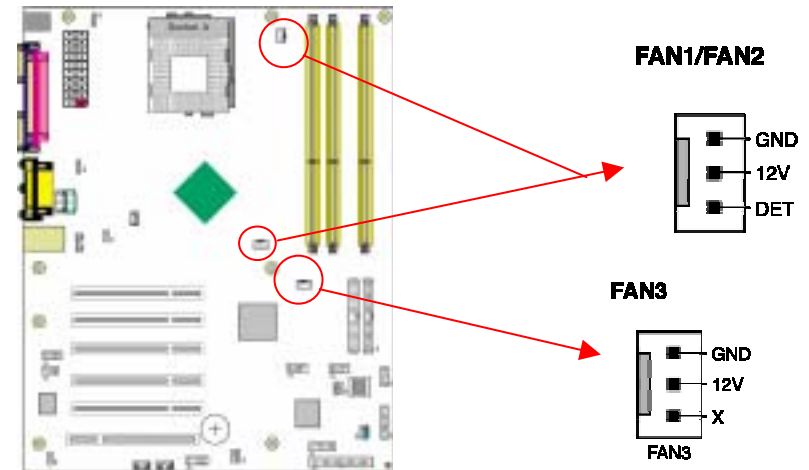
FAN1/FAN2/FAN3 (CPU/System/Case Cooling Fan Connectors):

The board's management extension hardware is able to detect the CPU and system fan speed in rpm (revolutions per minute). The wiring and plug may vary depending on the manufacturer. On standard fans, the red is positive (+12V), the black is ground, and the yellow wire is the rotation signal.

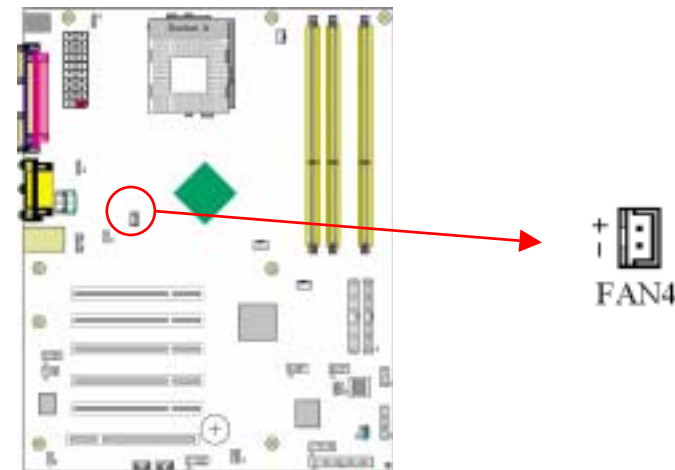
FAN4 (North Bridge Cooling Fan Power)

The wiring and plug may vary depending on the manufacturer. On standard fans, the red is positive (+12V) and the black is ground.

JP5 (Power On By Keyboard):

Pin	Definition
1-2	Disable (default)
2-3	Enable

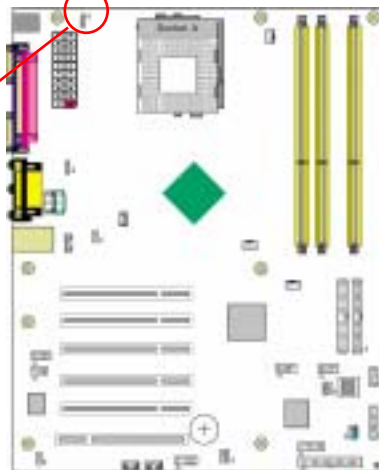

This board can be turned on by the PS / 2 keyboard (hot key). To use this function, select a hot key of your choice at the Hot Key Power On option under Wake Up Events in the BIOS's Power On Management screen. You must also set this jumper's cap to pins [2-3] to use this function.

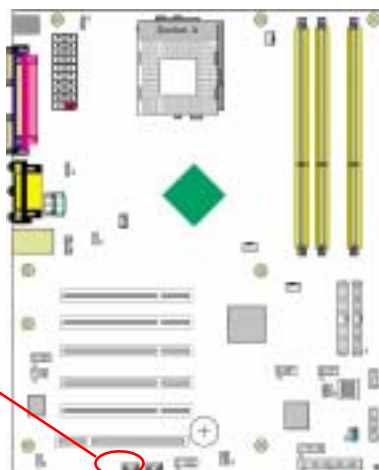
CN5 [WOL (Wake-on-LAN) Connector]:

Enable the Power On by Ring selection in BIOS's Power Management Menu to use this function. This header is used to connect an add-in NIC (Network Interface Card) which gives WOL capability to the motherboard.

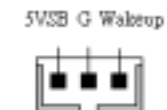
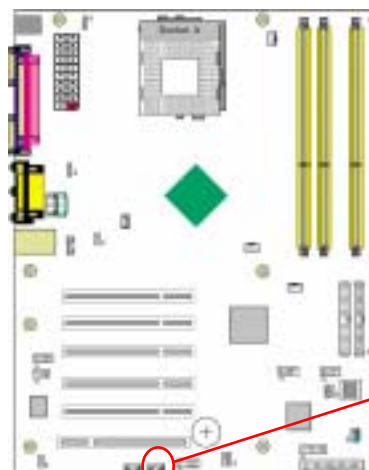
CN5A [WOM (Wake-on-Modem) Connector]:

Enable the Power On by Ring selection in BIOS's Power Management Menu to use this function. This header is used to connect an add-in modem card which gives WOM capability to the motherboard.

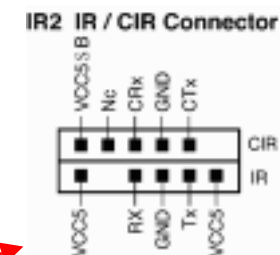
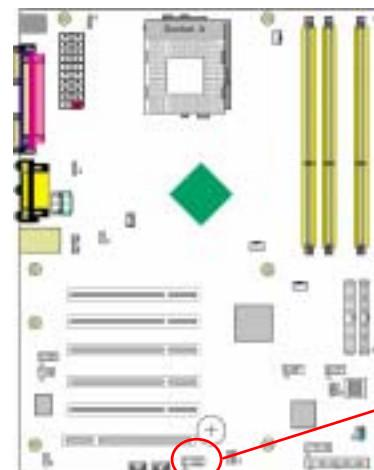
IR 2 (IR & CIR Connector):

Select a UART Mode in BIOS's Integrated Peripherals menu the UART port to support IR function. (See section 3.4 Super I/O Device of **Integrated Peripherals**)

JP23 (Green Mode LED):

Pin	Definition
1-2	CHAINTECH (default)
2-3	OEM

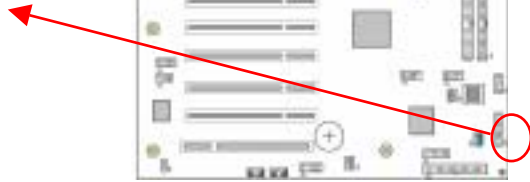
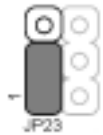

This cap is to setup Green LED flash mode. (Optional)

CN17 (Blue LED Connector):

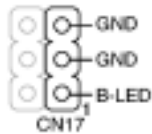

These features work entirely the same as the power indicator LED, both shows the system's power status. The only difference is that this one is blue while the other is red LED.

CN9 (Chassis Open Alarm Connector):

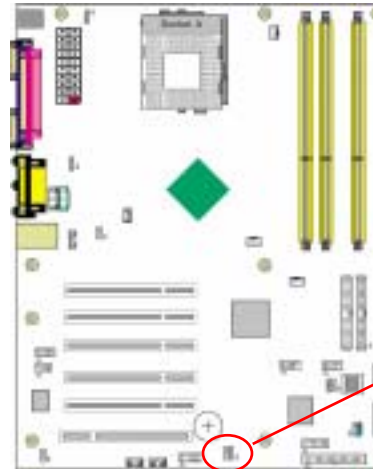

This connector provides a buzzer sound when an attempt to open the chassis occurs.

Note: Only certain chassis provides this function.

CN7 (Smart Card Reader Connector):

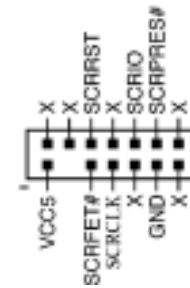
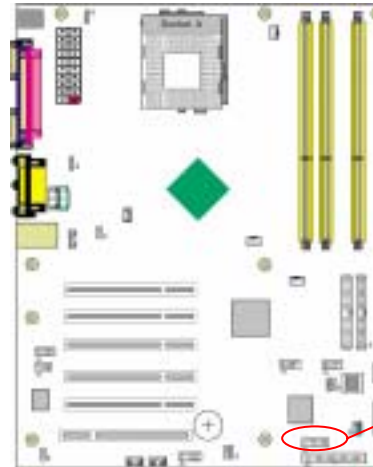

This connector must be connected to an optional Smart card reader.

2.6 CBOX™ 2 Setup

1. Gently insert **CBOX™2** into the regular 5-1/4" drive bay at the front of system chassis and securely tighten the side screws.
2. Connect Motherboard to **CBOX™ 2**

Function	Motherboard	CBOX™ 2
USB 2 & 3	CN23	CN1
USB 4 & 5	CN23A	CN2
*Front Audio	CN24	CN3
IEEE 1394	<i>None</i>	CN4
Green Mode LED	CN1A	2 pin
80 Port Display	CN25	CN6

Note: The 7NJI1 excludes IEEE 1394 function. If customers require IEEE 1394 function, please purchase one IEEE 1394 card to expand the function.

* Remove **CN24** Jumper Caps on motherboard **5-6, 9-10** before installation.

USB Cable (10 pin)	x 2
Front Audio Cable (10 pin)	x 1
80 Port Display (10 pin)	x 1
IEEE-1394 Cable	x 1
Green Mode LED Cable (2 pin)	x 1

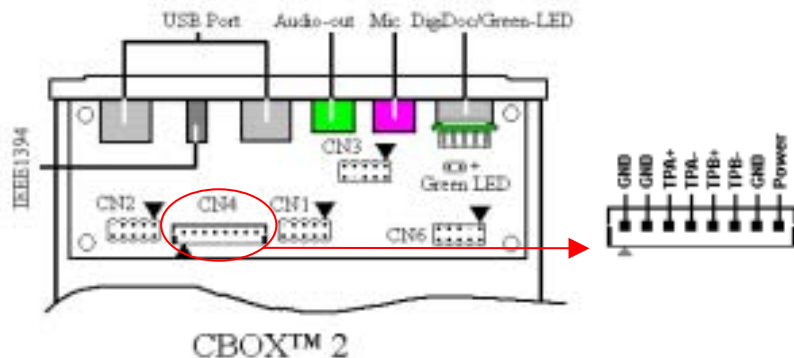

Note:

Each cable got **security-proof**.

Chapter 3 BIOS Setup Program

Phoenix-Award BIOS ROM has a built-in setup program that allows users to modify the basic system configuration. This information is stored in CMOS RAM so that it can retain the setup information, even when the power is turned off.

To enter the **Phoenix-Award BIOS** setup program press the [Delete key] when you **Power on** or **reboot** the computer system. The primary screen as shown in Figure 3-1 is a list of the menus and functions available in the setup program. Select the desired item by your arrow keys and press enter to make the changes. Operating commands are located at the bottom of this and all other BIOS screens. When a field is highlighted, on-line help information is displayed on the right side of the screen.

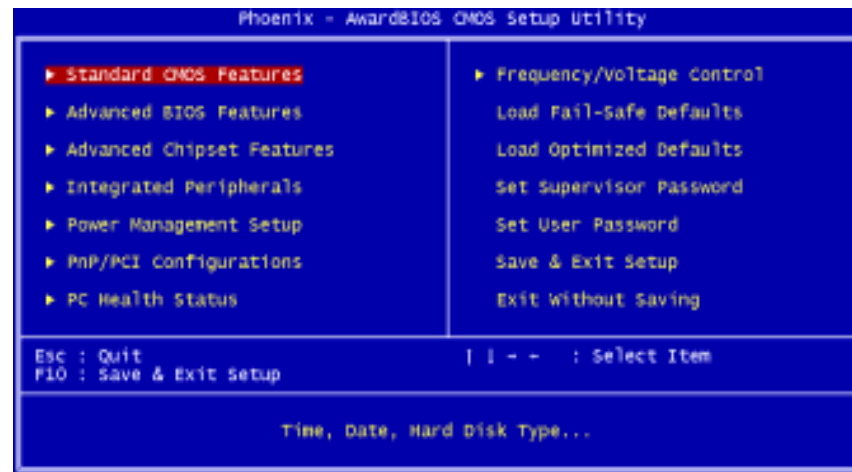

Figure 3-1

3.1 Standard CMOS Setup

The Standard CMOS Setup allows users to configure system components such as hard disk drive, floppy disk drive and video display as well as date, time and boot-up error signaling. This configuration menu should be changed when installing a motherboard for the first time, changing hardware in your system such as the HDD, FDD, video display, or when the CMOS data has been lost or contaminated. Choose the Standard CMOS Setup option from the CMOS Setup Utility menu (Figure 3-1) to display the following screen.



Figure 3-2

Date/Time:

Set the date and time of the system.

IDE (Primary/Secondary; Master/Slave):

This category identifies up to four IDE hard disk drives that have been installed in the computer. This section does not show information on other IDE devices such as CD-ROM drives or other hard drive type such as SCSI drives.

Drive A/B:

Select different Floppy device Model. Available options are [None], [360K, 5-1/4 in], [1.2M, 5-1/4 in], [720k, 3-1/2 in], [1.44M, 3-1/2 in], and [2.88M, 3-1/2 in].

Video:

Select the type of video adapter present in your system. You can ignore this setting if you are using a VGA monitor since VGA BIOS automatically configures this setting.

Halt On:

When the system is powered on, BIOS performs a series of diagnostic tests called POST (Power On Self Test). This function stops the computer if BIOS detects a hardware error. You can tell BIOS to halt on all errors, no errors, or not to halt on specific errors.

3.2 Advanced BIOS Features

By choosing the Advanced BIOS Features option from the CMOS Setup Utility menu (Figure 3-1), the screen below is displayed. This sample screen contains the manufacturer's default values for the motherboard.

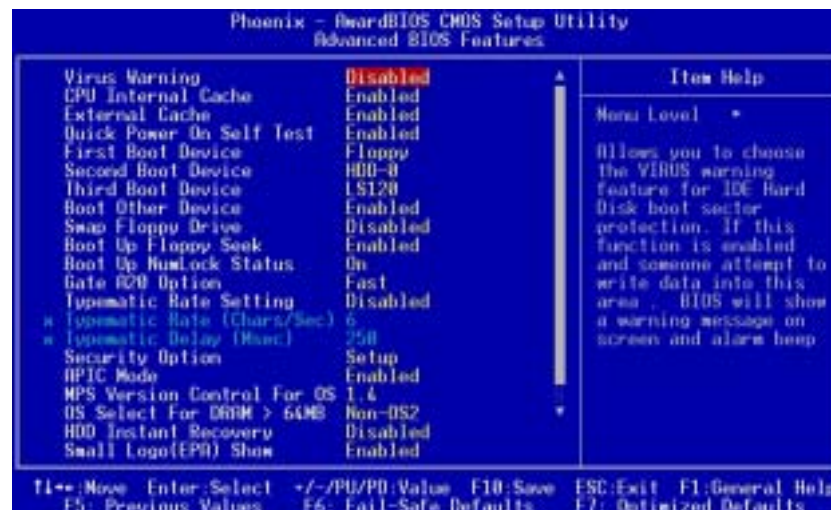

Figure 3-3

(1) Virus Warning:

When you set as enabled, you receive a warning message if a program (specifically, a virus) attempts to write to the boot sector or the partition table of the hard disk drive.

NOTE:

Many disk diagnostic programs that access the boot sector table can trigger the virus-warning message. If you plan to run such a program, we recommend that you first disable the virus warning.

(2) CPU Internal Cache/External Cache:

Cache memory is much faster than conventional DRAM system memory. These fields allow you to enable or disable the CPUs Level 1 built-in cache and Level 2 external cache. Both settings are left enabled to significantly increase the performance of your computer.

(3) Quick Power On Self Test (POST):

Enable this function to reduce the amount of time required to run the POST (Power On Self Test). BIOS will save time by skipping some items during POST. It is recommended that you disable this setting. Discovering a problem during boot up is better than losing data during your work.

(4) First/Second/Third/Boot Other Device:

This option sets the sequence of drives BIOS attempts to boot from after POST completes. BIOS will search these drives for an operating system.

(5) Swap Floppy Drive:

Enabling this function will swap the floppy drive assignment so that drive A will function as drive B, and drive B will function as drive A. Note that the boot sequence assignment mentioned directly above does not include booting from floppy drive B. This function is useful if floppy drives B and A are of a different format and you want to boot from floppy drive B.

(6) Boot up Floppy Seek:

This is a set up check for floppy power-on after starting the computer system.

(7) Boot Up NumLock Status:

This function defines the keyboard's number pad as number keys or arrow keys. If it is set at on the number keys will be activated, if it is set at off the arrow keys will be activated.

(8) Gate A20 Option:

This allows you to set the Gate A20 status. When set to **[Fast]**, Gate A20 is controlled by chipset. When set to **[Normal]**, Gate A20 is controlled by a specific pin from the keyboard controller. Available options are **[Fast]** and **[Normal]**.

(9) Keyboard Interface :**Typematic Rate Setting**

When enabled, you can set the following two-typematic control items. When disabled, the keyboard controller determines keystrokes arbitrarily in your system.

Typematic Rate (Chars/Sec)

The typematic rate sets the rate at which characters on the screen repeat when a key is pressed and held down.

Typematic Delay (Msec)

The typematic delay sets how long after you press a key that a character begins repeating.

(10) Security Option:

The Supervisor and/or User Password functions shown in Figure 3-1 must be set to take advantage of this function. See Section 3.11 for password setting information. When the Security Option is set to System, a password must be entered to boot the system or enter the BIOS setup program. When the Security Option is set to Setup, a password is required to enter the BIOS setup program.

(11) APIC Mode:

This item can enable or disable the APIC (**Advanced Programmable Interrupt Controller**). Due to compliance to PC2001 design guide, the system is able to run in APIC mode. Enabling APIC mode will expand available IRQs resources for the system. Available options are **[Enabled]** and **[Disabled]**.

(12) MPS Version Control OS:

This item allows you to select which MPS (**Multi-Processor Specification**) version to be used for the operating system. You need to select the MPS version which is supported by your operating system. To find out which version to use, consult the vendor of your operating system. Available options are **[1.4]** and **[1.1]**.

(13) OS Select (For DRAM >64MB):

If your system's DRAM is larger than 64MB and you are running OS/2, select OS/2 as the item value. Otherwise, set the item value to Non-OS/2 for all other operating systems.

(14) HDD Instant Recover:

This board supports HDD Instant Recover, Select enabled to use the function. Upon system boot up, the HDD Instant Recover Utility will be shown on the screen. Select enable or disable to continue booting. Available options are **[Disabled]** and **[Enabled]**.

(15) Small Logo(EPA) Show:

This setup allows photo that is EPA. Logo.

3.3 Advanced Chipset Features

By choosing the [Advanced Chipset Features] option from the CMOS Setup Utility menu (Figure 3-1), the screen below is displayed. This sample screen contains the manufacturer's default values for the motherboard.

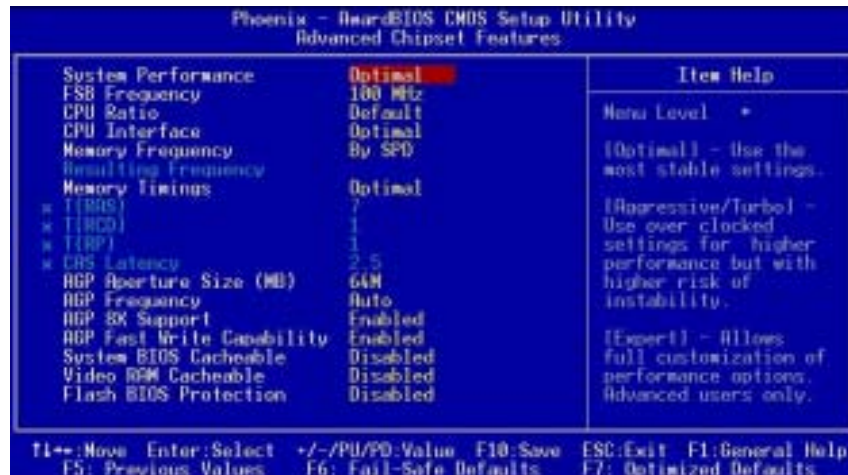

Figure 3-4 Advance Chipset Features

All of the above settings have been determined by the motherboard manufacturer and should not be changed unless you are absolutely sure of what you are doing. Explanation of the DRAM timing and chipset features setup is lengthy, highly technical and beyond the scope of this manual. Below are some abbreviated descriptions of the functions in this setup menu.

(1) System Performance:

Optimal: Select this option will let the system automatically detect its performance.

Aggressive: Select this option for better system performance. It increases a bit of the system performance.

Turbo: Select this option for a faster system performance. It will increase the system performance, but it might result in an unstable system.

Expert: Select this option only if you are a professional user. This will allow you to set the system performance according to your choice.

(2) FSB Frequency:

This feature allows the system memory to run at FSB clock speed. Options include **100 MHz (200 MHz)** to **200 MHz (400 MHz)**.

(3) CPU Ratio:

It is recommended to keep the default setting for stable system operation.

(4) CPU Interface:

Optimal: Select this option will let the system automatically detect its performance.

Aggressive: Select this option for better system performance. It increases a bit of the system performance.

(5) Memory Frequency:

By SPD: It automatically detects the memory frequency.

By Sync: This will cause the memory to detect the CPU's Ext. frequency and function synchronically.

WARNING

Overclocking:

This motherboard is designed to support overclocking. However, please make sure your components are able to tolerate such abnormal setting, while doing overclocking. Any attempt to operate beyond product specifications is not recommended. **We do not guarantee the damages or risks caused by inadequate operation or beyond product specifications.**

(6) Memory Timing:

The function allows you to enable or disable the DRAM timing by SPD. When it is set to Manual, you can select the DRAM CAS Latency, DDR SDRAM Cycle Length and Bank Interleave configuration.

(7) AGP Aperture Size (MB):

This function determines the amount of system memory that is given to the AGP card. Options range from **32MB** to **512MB**. This is a dynamic memory allotment in that the AGP card will only use the amount of memory that it needs. The remaining memory, which is not in use, will be available for the system. For example, if 16MB is allotted to the AGP card and the card only needs 8MB, the remaining 8MB will be available for system use.

(8) AGP Frequency:

This function determines the amount of AGP frequency that is given to the AGP card. Options range from **50 MHz** to **100 MHz**. (default [Auto (66MHz)])

(9) AGP 8X Support:

Enable this setting to utilize the 8X mode (twice as fast as 4X) offered by advanced AGP cards. Your VGA card must support 8X mode in order to take advantage of the faster speed.

(10) AGP Fast Write Capability:

Selecting [Enabled] to allow Fast Write Protocol for 8x/4x AGP to function.

PS: Not all AGP cards support fast write.

(11) System BIOS Cacheable:

Enabling this function allows caching of the system BIOS ROM at F0000h-FFFFFh, resulting in better system performance. However, if any program writes to this memory area, a system error may result. Caching the system BIOS results in better performance than shadowing the system BIOS.

(12) Video RAM Cacheable:

Enabling this function will allow caching of the video RAM, resulting in better system performance. However, if any programs write to this memory area, a system error may occur.

(13) Flash BIOS Protection:

The motherboard manufacturer developed BIOS protection technology that protects the System BIOS from accidental corruption by unauthorized users or computer viruses. When enabled, the BIOS data cannot be changed when attempting to update BIOS with the FLASH utility. When disabled, the BIOS data can be updated by using the FLASH utility.

3.4 Integrated Peripherals

This section provides information on setting peripheral devices. By choosing the Integrated Peripherals option from the CMOS Setup Utility menu (Figure 3-1), the screen below is displayed. This sample screen contains the manufacturer's default values for the motherboard.

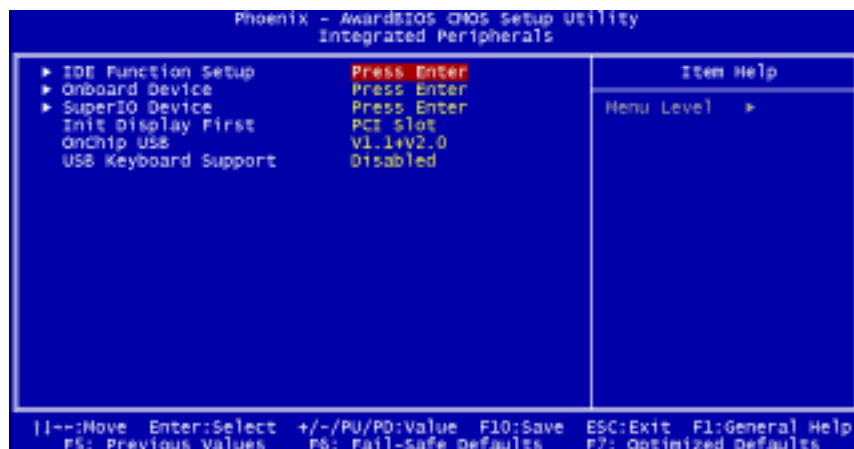

Figure 3-5 Integrated Peripherals Screen

(1) IDE Function Setup:

Press [**Enter**] to enter the sub-menu, which contains the following items for advanced control:

On Chip IDE channel 0/1:

You can set this to disable the On Chip IDE controller if you are going to add a higher performance IDE board.

IDE Primary/Secondary Master/Slave PIO:

The four IDE PIO (programmed Input/Output) fields let you set a PIO mode (0-4) for each IDE device that the internal PCI IDE interface supports. Modes 0 through 4 provide successively increased performance. In Auto mode, the system automatically determines the best mode for each device.

IDE Primary/Secondary Master/Slave UDMA:

Ultra DMA implementation is possible only if your IDE device supports it and your operating environment contains a DMA driver. If both your hard drive and software support Ultra DMA, select [**Auto**] to enable BIOS support.

IDE Pre-fetch Mode:

The onboard IDE drive interfaces support prefetching, for faster drive accesses. Set to [**Disabled**] if this primary or secondary

IDE HDD Block Mode:

Block mode is also called block transfer, multiple commands, or multiple sector read/write. If your IDE hard drive supports block mode, select Enabled to auto-detect the optimal number of block read/writes per sector the drive can support.

(2) Onboard Device:

This section provides information for setting onboard device. By choosing the Integrated Peripherals option from the CMOS Setup Utility menu (Figure 3-5), the screen below is displayed. This sample screen contains the manufacturer's default values for the motherboard.

Press [**Enter**] to enter the sub-menu, which contains the following items for advanced control:

AC97 Audio:

This feature allows you to enable/disable the on-board AC97 audio function.

MC97 Modem:

This item allows you to enable/disable the MCP chipset's feature to support MC97 Modem.

CMedia Audio:

This feature allows user to select 6 channels function, if that connect one **6ch Expansion kit** to motherboard.

MAC LAN (nVIDIA):

This item allows you to Auto / Disabled the onboard LAN function.

(3) Super IO Device:

This section provides information on setting Super I/O device. By choosing the Integrated Peripherals option from the CMOS Setup Utility menu (Figure 3-5), the screen below is displayed. This sample screen contains the manufacturer's default values for the motherboard.

Press **[Enter]** to enter the sub-menu, which contains the following items for advanced control:

Onboard FDC Controller:

Select Enabled if your system has a floppy disk controller (FDC) installed on the system board and you wish to use it. If you install an add-in FDC or the system has no floppy drive, select Disabled in this field.

Onboard Serial Port 1/2:

Select an address and corresponding interrupt for the first and second serial ports. Available options are **[3F8/IRQ4]**, **[2E8/IRQ3]**, **[3E8/IRQ4]**, **[2F8/IRQ3]**, **[Disabled]**, and **[Auto]**.

UART Mode Select:

This function allows you to select an operating mode for the second serial port. (Normal RS-232C serial port / IRDA / SCR / ASKIR 0.57-MB/sec infrared port)

Onboard Parallel Port:

Select a logical LPT port address and corresponding interrupt for the physical parallel port.

Parallel Port Mode:

Select an operating mode for the onboard parallel (printer) port. Select SPP unless you are certain your hardware and software support one of the other available modes.

ECP Mode Use DMA:

This item automatically specifies a DMA channel **1** or **3** for the parallel port when it is set to **[EPP]** or **[ECP+EPP]** mode.

Game Port Address:

This item disables or assigns the address of the Game port. Available options are **[201]** and **[209]**.

Midi Port Address:

This item disables or assigns the address of the Midi port. Available options are **[300]** and **[330]**.

Midi Port IRQ:

This item specifies an IRQ for the Midi port.

(4) Init Display First:

This function allows user to choose between **[Onboard / AGP slot]** or **[PCI slot]** to initialize Display first.

(5) On Chip USB:

Enable the on-board Universal Serial Bus (USB V1.1 or V2.0) controller if you want to connect a USB device to your system. Note that if this setting is disabled, you can still temporarily use a USB keyboard during boot up so that you can enter BIOS and enable this setting. If you pass the boot up stage without enabling this function, your PS/2 keyboard will no longer work.

Available options are **[Disabled]**, **[V1.1+V2.0]**, and **[V1.1]**.

(6) USB Keyboard Support:

Select Enabled if your system has a USB keyboard installed on the system board. If your system has no USB keyboard, select Disabled in this field.

3.5 Power Management Setup

This section provides information on the Green PC power management functions. By choosing the Power Management Setup option from the CMOS Setup Utility menu (Figure 3-1), the screen below is displayed. This sample screen contains the manufacturer's default values for the motherboard

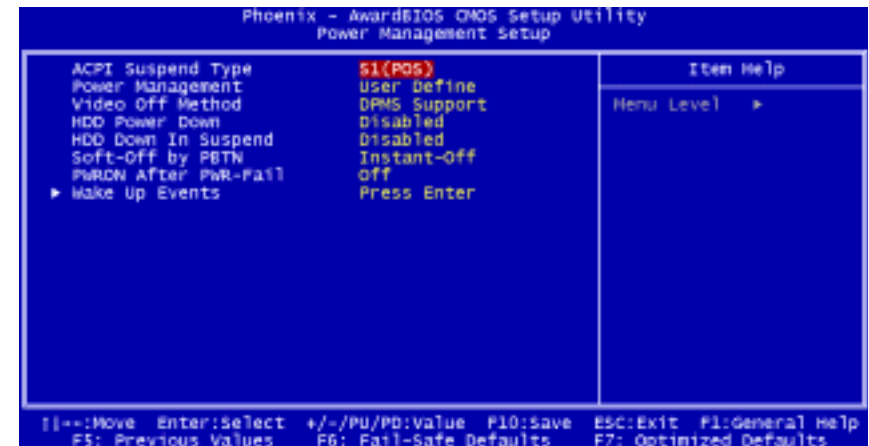

Figure 3-5 Power Management Setup

(1) ACPI Suspend Type:

This item specifies the power saving modes for ACPI function. Available options are:

S1 (POS):

The S1 state is low power state. In this state, no system context (CPU or Chipset) is lost and the hardware maintains all system contexts.

S3 (STR):

The S3 state is a lower power state, where the information of system configuration and opened applications / files are saved to main memory. The remaining power of other hardware components are turn off to save energy.

The information stored in memory will be used to restore the system when a [wake up] event occurs.

(2) Power Management:

Power management allows the computer to save electricity when it is not in use by entering increasingly deep power saving modes.

(3) Video Off Method:

This function serves as both a screen saver and power saver for monitors. See the next function, Video Off After, for setting the video timer.

Blank Screen - BIOS will only blank the monitor's screen. The electricity saved in this mode is negligible and this function is only used as a screen saver to prevent screen damage while the screen is on but not in use.

V/H SYNC+Blank - The system turns off the vertical and horizontal synchronization ports, writes blanks to the VGA buffer and the monitor's electron gun turns off. This function requires a monitor with Green features in order to take advantage of the power saving function. If you enable this function and do not have a Green monitor, the result will be the same as if you had selected Blank. This function serves as both a screen saver and a power saver.

DPMS Supported - Select this option if your video card supports the Display Power Management Signaling (DPMS) standard (i.e., you have a monitor that supports Green features). Use software supplied by your video subsystem to set video power management options.

(4) HDD Power Down:

Shuts down any IDE hard disk drives in the system after a period of inactivity as set in this user configurable field. This feature does not affect SCSI hard drives.

(5) HDD Down In Suspend:

In Suspend any IDE hard disk drives in the system after a period of inactivity as set in this user configurable field. This feature does not affect SCSI hard drives.

(6) Soft-Off by PBTN:

When set to Delay 4 Sec., this function allows the power button to put the system in Suspend, a power saving mode. When set to Instant-Off the Soft-Off by PWR-BTN function is disabled and the computer turns completely off when the power button is pressed.

(7) PwROn After PwR-Fail:

This allows you to set whether you want your system to reboot after the power has been interrupted. [Off] leaves your system off and [On] reboots your system. [Former-Sts] sets your system back to the state it is before the power interruption.

Configuration option: [Off], [On], [Former-Sts]

(8) Wake up Events**Power On by PME/OnBoard LAN (Nvidia):**

When enabled, the nVidia LAN, which is on Board, will be able to receive a signal and wake up the system from soft off and suspend mode. You should connect the LAN to the RJ45 port and turn on the resume event in suspend mode.

Power On by Ring:

When enabled, a Modem/LAN Card (**PCI Card or Ext. Modem**) will be able to receive a signal and wake up the system from soft off and green mode. You should connect the modem to the COM port and call your PC to power on.

USB Resume from S3:

Allows the activity of USB device to wake up the system from S3 power saving modes. Settings are [Enabled] and [Disabled].

Power On by Alarm:

When enabled, this setting allows the system to turn back on at a designated time of the month. User must designate date of month and time of day.

This function is only available when using an ATX power supply and the Software Power-Off function to turn off the computer.

POWER ON FUNCTION:

This control show the PS/2 mouse or keyboard can power on the system.

Available settings are [Password], [Hot KEY], [Mouse Move], [Mouse Click], [Any KEY], [BUTTON ONLY] and [Keyboard 98].

KB Power ON Password:

If POWER ON Function is set to [Password], then you can set a password in the field for the PS/2 keyboard to power on the system.

Hot Key Power ON:

If POWER ON Function is set to [Hot KEY], you can assign a hot key combination in the field for the PS/2 keyboard to power on the system.

Settings: [Ctrl-F1] through [Ctrl-F12].

3.6 PNP/PCI Configurations

This section provides IRQ and DMA setting information. By choosing the PNP/PCI Configuration option from the CMOS Setup Utility menu (Figure 3-1), the screen below is displayed. This screen contains the manufacturer's default values for the motherboard.

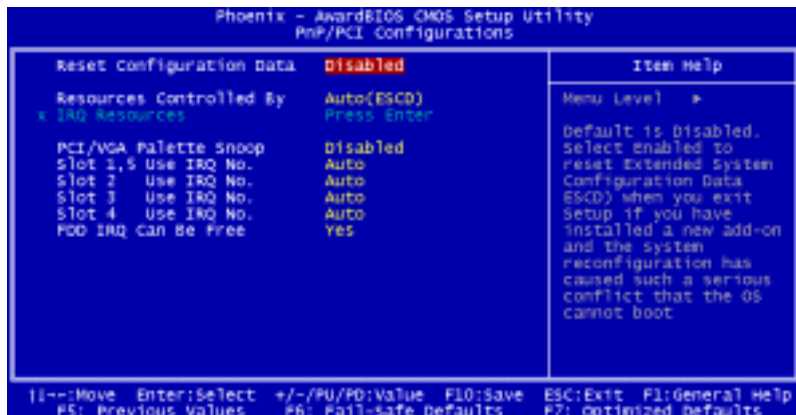

Figure 3-6 PNP/PCI Configurations

Reset Configuration Data:

If you want to reset CMOS IRQ divide hardware device, please selected to [Enabled].

Resources Controlled By:

When set to Manual the system BIOS will not refer to the ESCD for IRQ & DMA information. Instead, it will refer to the items in the setup menu for assigning IRQ & DMA. When set to Auto the system BIOS will refer to the ESCD for all legacy information.

ESCD (Extended System Configuration Data) provides a detailed format of the configuration data structures stored in flash memory. Each data structure defines the resources used by a device or a card in the system. This includes legacy and PCI/ISA PnP devices.

PCI/VGA Palette Snoop:

When set to [Enabled], multiple VGA devices operating on different buses can handle data from the CPU on each set of palette registers on every video device. Bit 5 of the command register in the PCI device configuration space is the VGA Palette Snoop bit (0 is disabled). Available options are [Enabled] and [Disabled].

Slot 1,5/2/3/4 Use IRQ No:

These Field automatically assign the IRQ for each PCI slot. The default setting for each field is [Auto], which utilizes auto-routing to determine IRQ assignments. Configuration IRQ option: [Auto], [3], [4], [5], [7], [9], [10], [11], [12], [14] and [15].

FDD IRQ Can Be Free:

This function allows user to choose if the FDD IRQ can be freed up. The default setting is Yes and this does not allow the IRQ to be free.

3.7 PC Health Status

By choosing the PC Health Status option from the CMOS Setup Utility menu (Figure 3-1), the screen below is displayed. This field shows you the current system temperature/external voltages input and the current CPU FAN and System FAN operating speed.

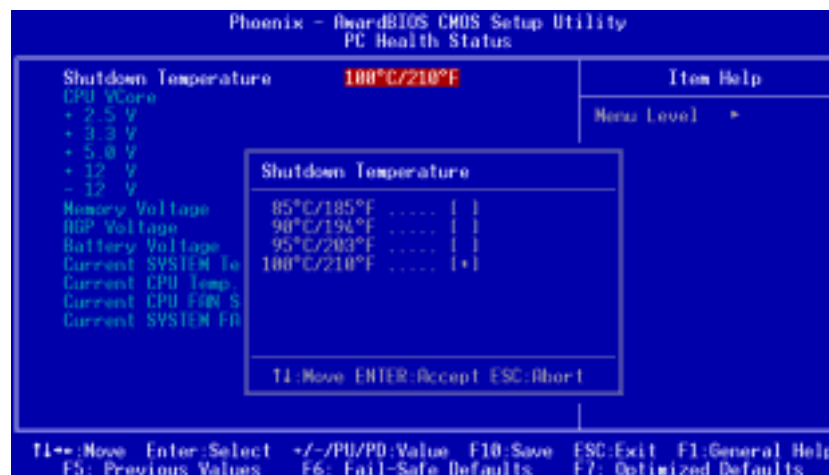

Figure 3-7 PC Health Status

Shutdown Temperature:

This item allows you to set the shutdown temperature level for the processor. When the processor reaches the temperature you set, this will shutdown the system. This function only works in ACPI-aware OS (such as Windows 98 / ME / 2000).

Available options are [85°C/185°F], [90°C/194°F], [95°C/203°F], and [100°C/210°F].

3.8 Frequency/Voltage Control

By choosing the Frequency/Voltage Control option from the CMOS Setup Utility menu (Figure 3-1), the screen below is displayed. This sample screen contains the manufacturer's default values for the motherboard.

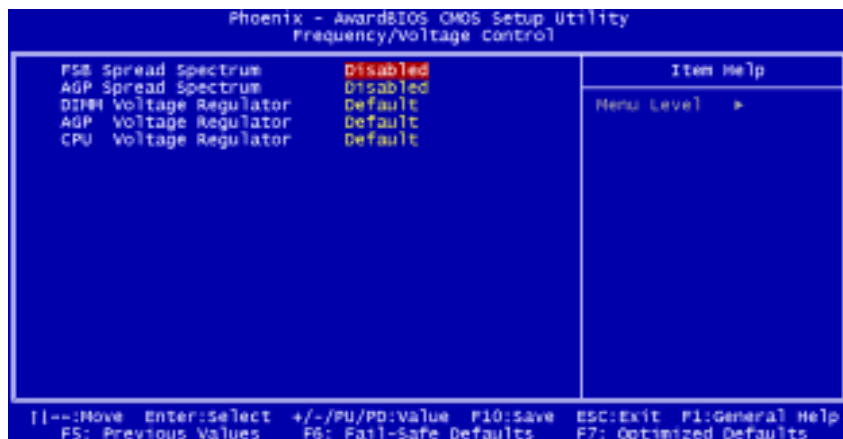

Figure 3-8 Frequency/Voltage Control

FSB/AGP Spread Regulator:

This item is used to enable or disable the clock generator's Spread Spectrum feature. When over clocking the processor, always set it to *Disabled*. Setting options: [0.5%], [1.00%], and [Disabled]

DIMM Voltage Regulator:

This feature allows the system memory to run at Power ON of Voltage.

AGP Voltage Regulator:

This feature allows the AGP bus to working of Voltage.

CPU Voltage Regulator:

This feature allows the CPU to working of Voltage. Available options are [1.400V] to [2.150V].

WARNING

Overclocking

This motherboard is designed to support overclocking. However, please make sure your components are able to tolerate such abnormal setting, while doing overclocking. Any attempt to operate beyond product specifications is not recommended. We do not guarantee the damages or risks caused by inadequate operation or beyond product specifications.

3.9 Load Fail-Safe Defaults

Load Fail-Safe Defaults loads the default BIOS values directly from the CMOS Setup Utility menu (Figure3-1). If the stored record created by the setup program becomes corrupted and therefore unusable, these defaults will be loaded automatically when you turn on the computer.

Load Fail-Safe Defaults (Y/N)? N

3.10 Load Optimized Defaults

Load Optimized Defaults loads the default system values directly from the CMOS Setup Utility menu (Figure3-1). If the stored record created by the setup program becomes corrupted and therefore unusable, these defaults will be loaded automatically when you turn on the computer.

Load Optimized Defaults (Y/N)? N

3.11 Supervisor Password & User Password Setting

There are four different variables that control password settings. The first two are located under the Security Option function in BIOS Features Setup Menu (Figure 3-1). When the Security Option function is set to **Setup**, a password is required to enter BIOS and change BIOS settings. When the Security Option function is set to **System**, a password is required to enter both BIOS and the computer's operating system (for example Windows 98) found on the boot drive.

The third and fourth variables are user password and supervisor password selected in BIOS (Figure 3-1). The main purpose of separating user and supervisor is to allow only the supervisor to have control over the settings in BIOS. The user, on the other hand, is only allowed to access the computer's operating system and change the user password in BIOS.

Note: that when there is no supervisor password set, the user password controls access to all BIOS settings.

Enter Password:

3.12 Save and Exit Setup

If you select this and type [Y] (for Yes) followed by the [Enter] key, the values entered in the setup utilities will be recorded in the CMOS memory of the BIOS chip.

SAVE to CMOS and EXIT (Y/N)? **Y**

3.13 Exit Without Saving

Selecting this option and pressing Y followed by the [Enter] key lets you exit the Setup program without recording any new values or changing old ones.

Quit without saving (Y/N)? **N**

Chapter 4 DRIVER Setup

Please, insert nVidia Series CD to CDROM.



Figure 4-1

4.1 Nvidia Driver Package Setup

1. Please, select [Nvidia Driver Package]
2. Please, select [NEXT]



3. Please, select [YES]

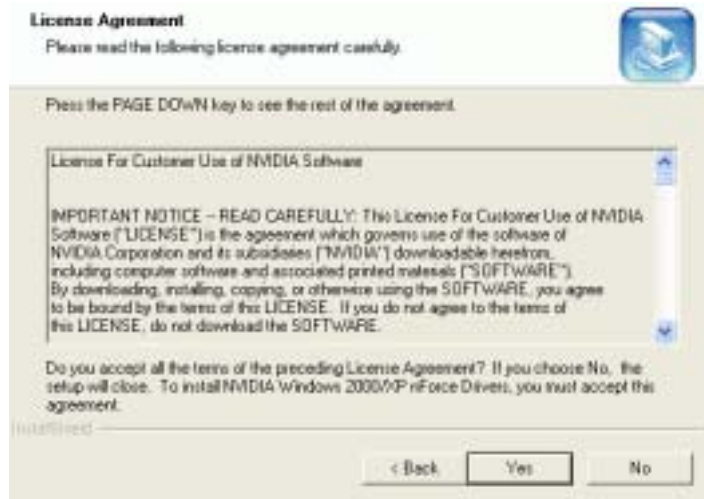

4. Please, select [Next]



5. Please, select [Yes]

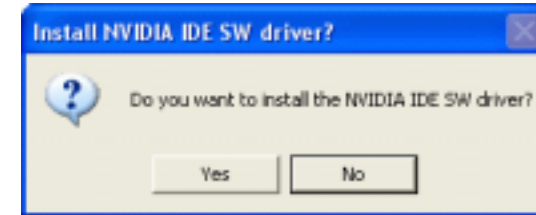

6. Please, select [Continue Anyway]

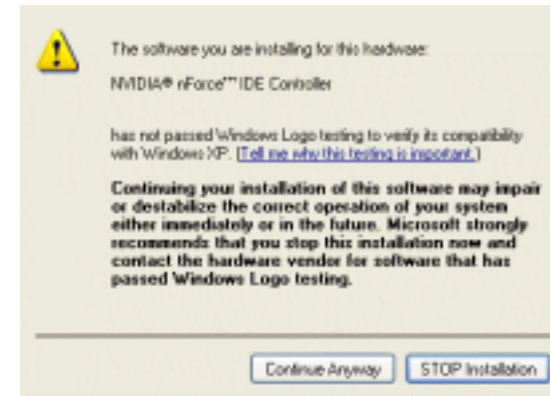

7. Please, select [Continue Anyway]

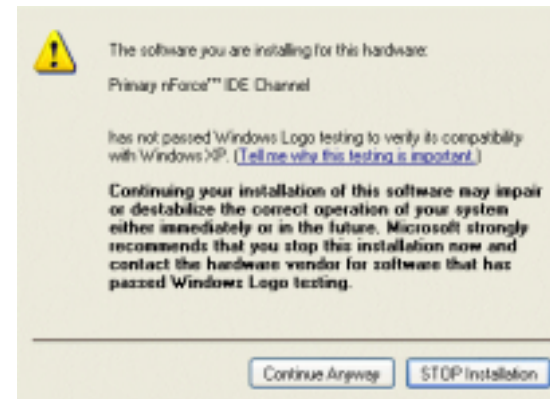

8. Please, select [**Continue Anyway**]

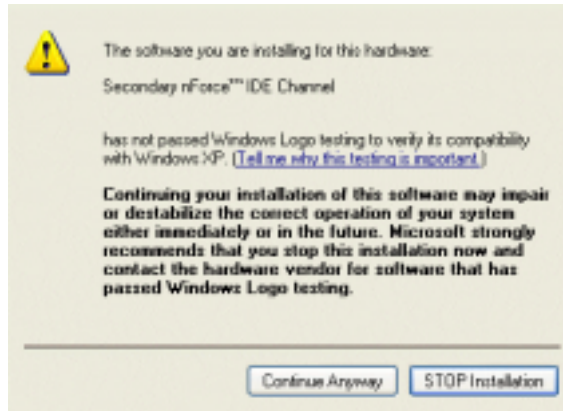

9. Please, select [**Finish**] after restart



Note:

Please check BIOS be enabled to on LAN function.

4.2 USB 2.0 Driver Setup

This section provides information on installed audio devices by choosing [**USB 2.0 Driver**] from the Setup Driver menu. (Figure 4 - 1)

Note: USB 2.0 only support Windows 2000 / XP operation system.

Windows XP:

- Open Device Manager and open the properties for the USB 2.0 host controller.
- Select [**Update Driver**].
- Point the installer to the folder with the USB 2.0 drivers.
- It should select **CDROM:\NVUsb2.0\WinXP** the **USB2X.inf** and then install the system files.
- The host controller should be installed correctly when Device Manager is updated after the install.

4.3 C-MEDIA Sound Driver Setup

This section provides information on installed audio devices by choosing [**Audio Drivers**] from the Setup Driver menu. (Figure 4 - 1)

1. Please select [**Audio Drivers**]



2. Please select [**Install Device Driver and Application**]



3. Please select [**OK**]

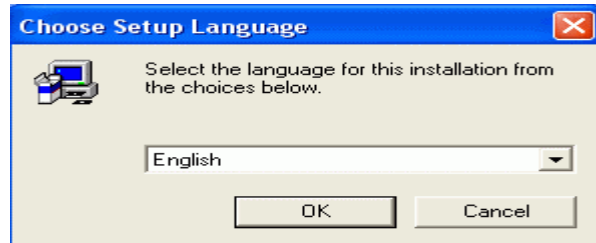

4. Please select [**Next**]



5. Please select [**Next**]

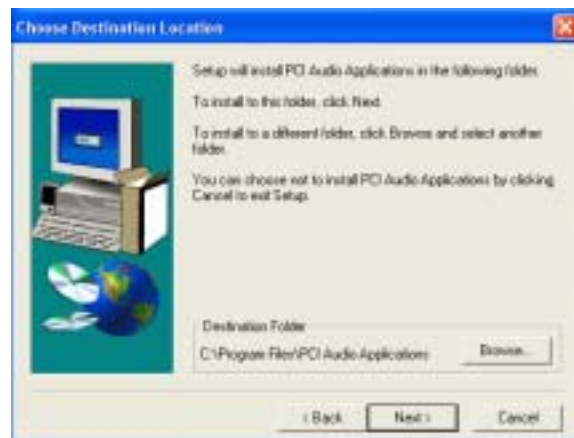

6. Please select [**Next**]



7. Please wait; select [**OK**], after restart.



8. Select different channels according to you speakers



Chapter 5 Audio Device Application

This sound card supports Windows 95/98/ME/NT4.0/2000 operating systems. To start the Audio Application Program simply select the [Start] [Program Files] [PCI Audio Applications] [Audio Rack]

It includes the following options:

- (1) **Audio Rack:**
Which includes Audio Rack, CD Player, MIDI Player, Mixer and MP3 Player.
- (2) **Multi-Channel Audio Demo:**
(Does not support Windows NT4.0)
A demonstration for the Multi-Channel Audio.
- (3) **Uninstall Applications:**
Which uninstalls the driver and all application programs for the Sound card.

5.1 Audio Rack

Audio Rack includes 4 control panels:

- C-Media Mixer Volume
- CD Player
- MIDI Player
- MP3 Wave Player

You can start the Audio Rack by selecting [Start] [Program] [PCI Audio Applications] [Audio Rack]



CD Player Output Configuration

MIDI Player Output Configuration

MP3 Wave Player Configuration

Mixer Setup

1. C-Media Mixer Volume

A. Volume Control



You can simply double click the icon  located at button right corner of Windows to open the C-Media Mixer volume control.

This control panel includes Master Volume, CD Audio, Microphone, WAVE, SW Synth, A/V (AUX) In, MONO IN, and LINE IN.

B. Mixer Recording Control

This control panel includes CD Audio, Microphone, WAVE, Stereo Mix, A/V (AUX IN), and LINE IN.



C. [Help]



D. Mixer Advance Setting:

(1) Speakers:

- Headset & 2 channel speaker setup



- 4 channel speaker setup



- 6 channel speaker setup



- User 4ch XeaR mode setup



- User 6ch XeaR mode setup



(2) Volume:

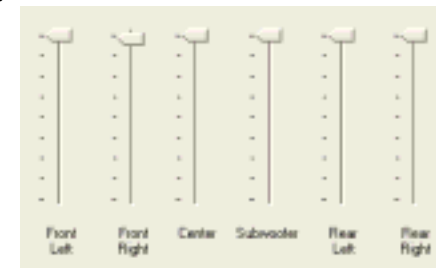

(3) Sound Effect:

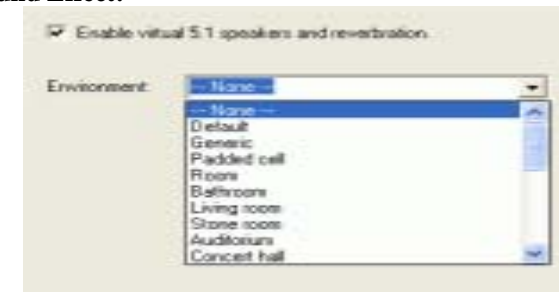

(4) Option:**【Enable Hot Keys】**

This provides settings for Hot-Keys for Volume control, Mute, and Display.

【Enable Microphone Booster】

Enable the microphone's electrical circuit to increase the sensitivity of the microphone. When designing the audio chip, it limits the type of microphones that are available. The audio chip only supports Active or Capacitive types of Microphone. These microphones are those standard microphones we get on the market, or those earphones that come with a microphone. The one that Karaoke uses does not work on this chip.

【Load Mixer Defaults】

This loads the original factory setting for the Sound Effects. (It restores Volume, Wave, and MIDI.)

2. CD Player Output Configuration:**Setup :**

(1) Enable to choose the Audio CD drive of your system.

[Help]**3. MIDI Player Output Configuration:****Setup:**

- A. Under Win 95 / 98**
3 options available for Output device: [Default MidiOut Device], [MPU-401], [Microsoft GS Wavetable SW Synth].
- B. Under Windows NT4.0**
Only CMPCI MIDI device is available.
- C. Under Windows 2000 / ME / XP**
3 options available for Output device: [MidiOut Device], [Microsoft GS Wavetable SW Synth], [Roland MPU-401]

[Help] :



4. MP3 WAVE Player Configuration:



Sound Effector Setting Button:

- (1) **Reverberation:**
This is to setup the depth of the sound environment.
- (2) **Equalizer:**
This is to setup the high and low pitch of the sound frequency output.
- (3) **Surround:**
This is for setting up speaker output mode.
- (4) **Playback Mode**
To select the music playback mode provided.

Configuration:

Playback:

Playback delay time for Mini-Disk recording. Please use default setting.

Recording Configuration:

Recording Format:

Quality:

- (1) **Name:**
This is to setup the recording format. There are 3 selections: CD Quality, Radio Quality, and Telephone Quality. The default setting is CD Quality.
- (2) **Format:**
Only PCM format is available while recording with audio card.
- (3) **Attributes:**
Enabling to setup recording quality. The default is set at 44.100 kHz 16Bit Stereo 172 kb/sec
- (4) **File Name:**
Enable to setup the recording source. Type in the file name you plan to record or click on the [BROWSE] icon and select the desired file save destination.

[Help]:

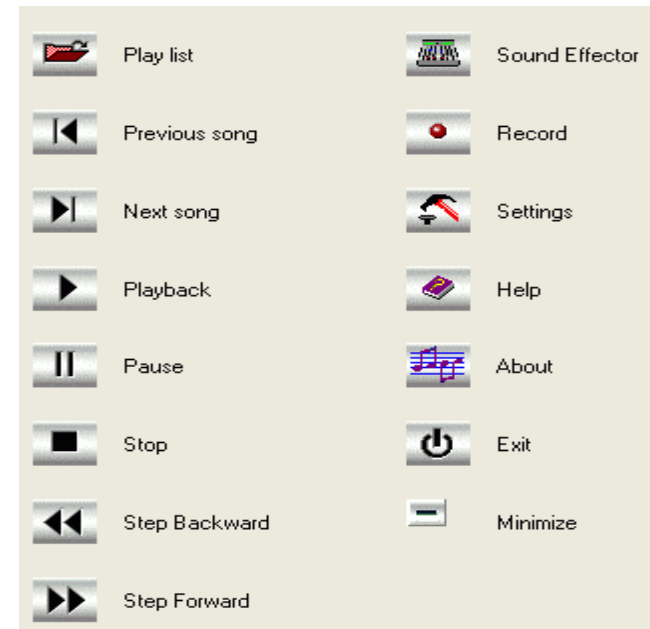

5.2 Multi- Channel Demo

[STAR] [Program] [PCI Audio Applications]
[Multi-Channel Demo]



Click on the **wide-screen TV** in the center to get into [Advance] screen

1. Set speaker function for demo mode:

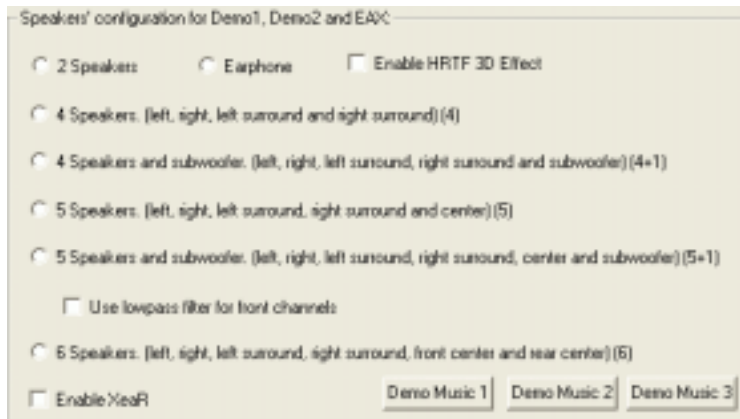

2. Set EAX function for demo mode:

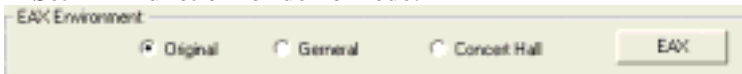

In Advance mode, here you can configure according to your system hardware or personal preference.

Chapter 6 DigiDoc

“DigiDoc” is the most advance system diagnostic monitoring display.

- CPU temperature monitoring, your system stays cool always!
- DigiDoc is THE doctor for your system!



DDR Memory TEST Table**CPU FSB=266MHz DDR**

Memory List

Product Name	Vendor	Component
128MB DDR266 (CL:2.5)	Apacer	Samsung K4H280838B-TCB0
256MB PC2100 (CL:2.5)	Apacer	Samsung K4H280838B-TCB0
256MB PC2700 (CL:2.5)	Apacer	Samsung K4H560838C-TCB3
128MB PC-2100 (CL2)	Apacer	Nanya NT5DS16M8AT-7K
512MB PC-2700 (CL:2.5)	Apacer	Winbond W942508AH-6
128MB DDR266 (CL:2.5)	Buffalo	Samsung K4H280838B-TCB0
128MB PC-2100	TWINMOS	Hyundai HY5DU28822T-H
512MB PC-2100 (CL2.5)	TWINMOS	Winbond W942508AH-75
256MB PC-2700 (CL2.5)	TWINMOS	Hynix HY5DU28822AT-K
512MB PC-2700 (CL2.5)	TWINMOS	Winbond W942508AH-6
256MB PC-3200	TWINMOS	TwinMOS TMD7608F8E50B
128MB DDR266 (CL:2)	VIA	NANYA NT5DS16M8AT-7K
256MB PC-2100 (CL2.5)	Hynix	Hyundai HY5DU28822AT-H
128MB DDR266 (CL:2)	Micron	Micron MT 46V16M8-75A
256MB PC-2100	PR	Nanya NT5DS16M8AT-7K

Product Name	Vendor	Component
128MB PC-2100 (CL:2.5)	Samsung	Samsung K4h280838B-TCB0
512MB DDR300 (CL:2.5)	Samsung	Samsung K4h280838B-TCB0
256MB DDR333 (CL:2.5)	Nanya	Nanya NT5DS16M8AT-6
128MB DDR333 (CL:2.5)	Nanya	Nanya NT5DS16M8AT-6
256MB DDR266 (CL2)	Nanya	Nanya NT5DS16M8AT-7K
512MB DDR266 (CL2)	Nanya	Nanya NT5DS16M8AT-7K
256MB DDR300 (CL2.5)	KingMax	KingMax KDL684T4A2A-06
256MB DDR266 (CL:2.5)	PQI	Hynix HY5DU28822AT-H
256MB DDR266	PQI	PQI PQ6D328C75
128MB PC2100	AData	NANYA NT5DS16M8AT-75B
512MB PC3200	AData	Winbond W942508BH-5
512MB KVR333	Kingston	Winbond W942508AH-6
256MB PC333	Transcend	Samsung K4H560838D-TCB3

CPU FSB=333MHz DDR

Memory List

Product Name	Vendor	Component
128MB DDR266 (CL:2.5)	Apacer	Samsung K4H280838B-TCB0
256MB PC2100 (CL:2.5)	Apacer	Samsung K4H280838B-TCB0
256MB PC2700 (CL:2.5)	Apacer	Samsung K4H560838C-TCB3
128MB PC-2100 (CL2)	Apacer	Nanya NT5DS16M8AT-7K
512MB PC-2700 (CL:2.5)	Apacer	Winbond W942508AH-6
256MB PC-2700 (CL:2.5)	Apacer	Winbond W942508AH-6
128MB DDR266 (CL:2.5)	Buffalo	Samsung K4H280838B-TCB0
128MB PC-2100	TWINMOS	Hyundai HY5DU28822T-H
512MB PC-2100 (CL:2.5)	TWINMOS	Winbond W942508AH-75
256MB PC-2700 (CL:2.5)	TWINMOS	Hynix HY5DU28822AT-K
512MB PC-2700 (CL:2.5)	TWINMOS	Winbond W942508AH-6
256MB PC-3200	TWINMOS	TwinMOS TMD7608F8E50B
128MB DDR266 (CL:2)	VIA	NANYA NT5DS16M8AT-7K
256MB PC-2100 (CL2.5)	Hynix	Hyundai HY5DU28822AT-H
128MB DDR266 (CL:2)	Micron	Micron MT 46V16M8-75A

Product Name	Vendor	Component
256MB PC-2100	PR	Nanya NT5DS16M8AT-7K
128MB PC-2100 (CL:2.5)	Samsung	Samsung K4H280838B-TCB0
512MB PC-2100 (CL:2.5)	Samsung	Samsung K4H560838C-TCB0
256MB DDR333 (CL2.5)	Nanya	Nanya NT5DS16M8AT-6
128MB DDR333 (CL2.5)	Nanya	Nanya NT5DS16M8AT-6
512MB DDR266 (CL2)	Nanya	Nanya NT5DS32M8AT-7K
256MB DDR266 (CL2)	Nanya	Nanya NT5DS16M8AT-7K
256MB DDR300 (CL2.5)	KingMax	KingMax KDL684T4A2A-06
256MB DDR400 (CL2.5)	KingMax	KingMax KDL684T4AA-50
256MB DDR266 (CL:2.5)	PQI	Hynix HY5DU28822AT-H
256MB DDR266 (CL:2.5)	PQI	Hynix HY5DU28822AT-H
128MB PC2100	AData	NANYA NT5DS16M8AT-75B
512MB PC3200	AData	Winbond W942508BH-5
512MB KVR333	Kingston	Winbond W942508AH-6
256MB PC333	Transcend	Samsung K4H560838D-TCB3

Notes

WARNING *Overclocking*

This motherboard is designed to support overclocking. However, please make sure your components are able to tolerate such abnormal setting, while doing overclocking. Any attempt to operate beyond product specifications is not recommended. We do not guarantee the damages or risks caused by inadequate operation or beyond product specifications.

All rights are reserved for the products and corporate names/logos that appear in this manual to their original owners.

CHAINTECH reserves all the rights to change this manual .All information is subject to change without notice.

How To Contact CHAINTECH

Please do not hesitate to contact us if you have any problem about our products. Any opinion will be appreciated.

For Asia, Africa, Australia and Pacific Island: CHAINTECH COMPUTER CO., LTD No. 7-1, Chung Shin Rd., Tu Cheng, Taipei Hsien, Taiwan, ROC. Tel: +886-2-2268-9998 Fax: +886-2-2269-7510 URL: http://www.chaintech.com.tw E-mail: sales@chaintech.com.tw	For America: CHAINTECH AMERICA CORP. 4427 Enterprise St. Fremont CA 94538, U.S.A. Tel: +1-510-656-3648 Fax: +1-510-656-2297 URL: http://www.chaintechusa.com E-mail(Sales): sales@chaintechusa.com
For UK: CHAINTECH UK., LTD. 7200 The Quorum, Oxford Business Park North, Oxford, OX42JZ, UK Tel: 44-1865-487-165 Fax: 44-1865-481-482 E-Mail: phil@chaintech.nl	For China CHAINTECH, SHENZHEN 301, Nanguang Building, No.1004, Huaifu Rd, Futian District, Shenzhen, China 518041 Tel: +86-755-8368-9072 Fax: +86-755-8368-9053 CHAINTECH, BEIJING 403, Building A, No.118, Zhichun Rd, Haidian District, Beijing, China 100086 Tel: +86-10-6265-1626 Fax: +86-10-6262-0267 URL: http://www.chaintech.com.cn E-MAIL: chaintech@21cn.com
For The Netherlands: CHAINTECH EUROPE B.V. Coenecoop 620 2741 PV WADDINXVEEN, THE NETHERLANDS Tel: +31-182-623-960 Fax: +31-182-623-969 URL: http://www.chaintech.dk Technical support E-Mail: support@chaintech.nl	For France: AELT COMPUTER 5 rue de Rome 93561 Rosny Sous Bois Cedex France Tel: 33-1-4855-5940 Fax: 33-1-4855-5942 E-mail: infos@chaintech-france.com
For Italy and Southern Europe: CELT COMPUTER s.r.l. Via Privata Mulino 3 I-20090 Buccinasco, Milano, Italy Tel: +39-2-4510-9108 Fax: +39-2-4510-1354 E-Mail: celt@libero.it	For Korea: CHAINTECH KOREA CO., LTD. 14F, Mi-Won B/D, Yeouido-Dong 43, Youngdeunpo-Gu, Seoul, Korea Tel: +82-2-6332-3377 Fax: +82-2-6332-3379 E-Mail: erin@chaintechkorea.com